

## STROMABNEHMER AUS KOHLE

Hartkohle-Qualitäten      Metallgraphitkohle-Qualitäten      Metallimprägnierte-Qualitäten

Kohleschleifstücke für Stromabnehmer aller Art haben sich durch ihre hervorragenden Eigenschaften auf fast allen Gebieten durchgesetzt und glänzend bewährt. Die früher verwendeten Buntmetallstromabnehmer hatten einen großen mechanischen, sowie elektrischen Verschleiß infolge Lichtbögen, die zu Schmelzperlenbildung führten.

Unsere Qualitäten sind den jeweiligen Anforderungen angepaßt, insbesondere hinsichtlich der Abnutzung der Kohle und äußerster Schonung des Fahrdrahtes, welcher bei Verwendung von Kohleschleifstücken mit einem graphitreichen Schutzfilm überzogen wird und die Reibung und damit die Abnutzung wesentlich mildert.

Infolge dieser glatten Gleitflächen werden Lichtbögen und Rundfunkstörungen vermieden.

Unsere Kohleschleifstücke sind mit einem wasserabweisenden Mittel imprägniert, um die schädlichen Einflüsse von Feuchtigkeit auszuschalten, bei Einsatz im Freien.

Durch Niederschläge, mitgeführte Verunreinigungen oder salzhaltige Luft, werden auf dem Stromabnehmer chemische Reaktionen frei, die sich schädlich auswirken.

Der Anpreßdruck variiert entsprechend dem jeweiligen Verwendungszweck, z. B. Kranbahnen, Grubenbahnen, O-Busse, S-Bahn und Transportanlagen in weiten Grenzen von etwa 30 - 100 N.

Als Anpreßkraft für den Linienkontakt empfehlen wir ca. 15 N, für den Flächenkontakt ca. 5 N/cm<sup>2</sup> min.

In dieser Liste sind nur die gängigsten Typen aufgeführt. Wir stellen selbstverständlich auch jede gewünschte andere Ausführung her und bitten in diesem Falle um Einsendung von Mustern oder Skizzen.

## CURRENT COLLECTORS OF CARBON MATERIAL

Carbon inserts have obtained high reputation on account of their excellent characteristics. The former used nonferrous metal current collectors had a big mechanical and electrical wear due to arcs, which caused welding beads.

Our qualities have been adopted to the individual demands, especially with regard to abrasion of the carbon and extreme careful treatment of the bus bar line, which is covered with protective film of high graphite contents, resulting in an essential decrease of friction and thus wear.

Arcs and radio interference suppression are thus avoided.

Carbon current collectors cannot be used, if the bus bar line is made of light metal material.

Our carbon inserts are supplied impregnated with a water-repellent liquid as to avoid harmful influences caused by humidity.

Chemical reactions which show bad influences become free by precipitation, by pollution or salty ambient conditions.

The pressure is varying in vast limits of 3 to 10 kgs., corresponding to the individual application, i.e. cranes, mine traction motors, trolleybuses, subways and transport equipment.

This list contains standard items only; besides those listed we manufacture any further requested performances.

## FROTTEURS EN CHARBON POUR PRISES DE COURANT

Les frotteurs en charbon pour prises de courant se sont imposés et ont fait leur preuve dans un très grand nombre de domaines, à cause de leurs multiples qualités.

Dans le passé, l'emploi des frotteurs en métaux non-ferreux était courant, mais leur usure rapide tant électrique que mécanique incita l'utilisateur à les remplacer par des frotteurs en charbon.

Nos qualités sont conformes aux multiples exigences, spécialement en ce qui concerne l'usure du frotteur et le ménagement du fil trolley, qui sera recouvert par un filin protecteur graphité, réduisant au minimum le frottement, donc l'usure.

Ces surfaces de frottement lisses évitent l'arc électrique ainsi que les perturbations radiophoniques.

Tous nos frotteurs en charbon sont imprégnés, évitant ainsi toute pénétration d'humidité.

Les précipitations, l'entraînement de saletés, ou d'autres nuisances, l'air salin peuvent provoquer des réactions chimiques nuisibles sur le frotteur.

La pression sur le frotteur peut varier suivant son utilisation, par exemple; sur ponts-roulants, locos de mine, trolleybus, métro, installations diverses de transport, entre 3 et 10 kg.

Ce catalogue ne présente que les types les plus courants.

Pour toute exécution autre que celles qui en font l'objet, prière de nous consulter à l'appui de dessin ou modèle.

Reference	Abmessungen - dimensions							Bemerkungen remarks remarques
	a	b	c	e	f	g	h	
07.02.01	80	26	24	6	8,5	12,5	5	Kanten gebrochen, ganz verkupfert halb verkupfert
07.02.02	80	25	24	6	7,5	11	3	
07.02.03	80	25	23	6	9	14	4	
07.02.04	80	20	25	6	7,5	9	4,5	ganz verkupfert
07.02.05	80	26	24	7	7,5	13	7	
07.02.06	80	25	25	5	7,5	14	4	
07.02.07	100	25	24	7	7	11	3	
07.02.08	79	25	23	9	10	15	4	
07.02.10	100	25	25	8,5	8,5	8	4	
07.02.11	100	50	30	8	8,5	20	4,5	ganz verkupfert
07.02.12	100	20	32	6,5	6,5	11	2,5	
07.02.14	80	26	24	7	7,5	12	5	
07.02.15	80	25	25	7	7,5	12	5	
07.02.16	80	26	17	6	7,5	-	-	
07.02.17	80	24	24	7,5	8	9,5	3	
07.02.18	80	25	23	8,5	10	14	4	
07.02.19	100	25	27	7	7,5	15	4	
07.02.20	79	25	23	10	10	14	4	

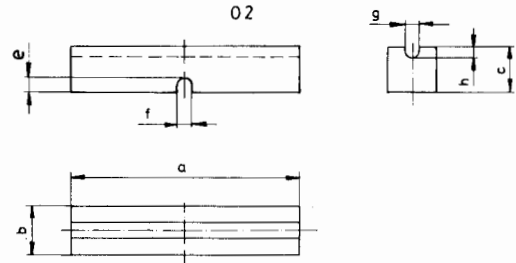

Reference	Abmessungen - dimensions								Bemerkungen remarks remarques
	a	b	c	e	f	g	h	i	
07.05.01	80	30	30	7	7	8	4	50	seitliche Bohrung, d = 5mm ganz verkupfert
07.05.02	110	26	24	7,5	7,5	12	6	83,5	
07.05.03	130	20	30	7	7,5	10	4	79,5	
07.05.04	120	25,8	24	7	7	12	6	95	ganz verkupfert
07.05.05	110	26	25	7,5	7,5	12	6	83,5	
07.05.07	90	25	25	8	7	16	4	62	
07.05.08	90	20	25	7	6,5	7	4	62	
07.05.09	80	30	30	7	7	8	2	50	Nut nicht verkupfert
07.05.10	110	26	24	7	8	12	6	86	

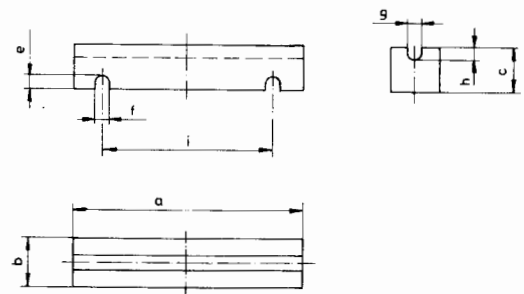

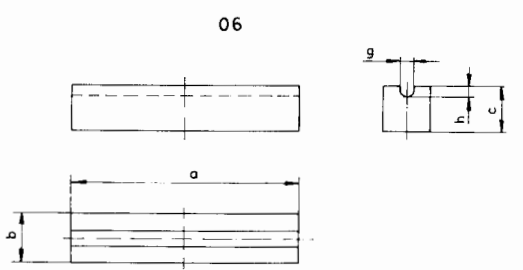

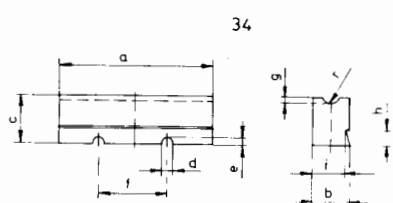

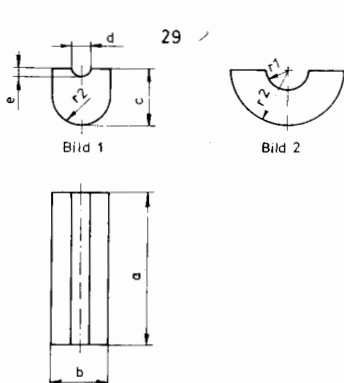
Reference	Abmessungen - dimensions					Bemerkungen remarks remarques
	a	b	c	g	h	
07.06.01	96	25	25	11	4	06 
07.06.02	115	30	25	13	6	
07.06.03	60	25	28	11	10	
07.06.04	-	-	-	-	-	
07.06.05	120	18	20	12	4	
07.06.07	80	30	28	11	6	
07.06.08	110	18	23	6,5	3	
07.06.09	100	25	25	12	6	
07.06.10	92,4	23,81	17,86	10	1,5	
07.06.11	90	28	18	14,5	4	
07.06.12	120	25	40	10	5	
07.06.13	85	20	25	10	4	
07.06.14	120	18	20	12	3	
07.06.15	95	25	25	10	5	
07.06.16	58	28	20,5	14	5	
07.06.17	120	40	30	24	9,5	

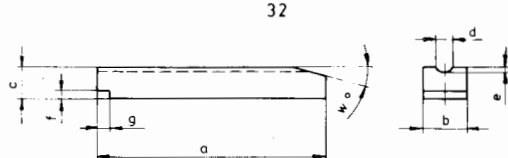
Reference	Abmessungen - dimensions										Bemerkungen remarks remarques
	a	b	c	d	e	f	g	h	i	r	
07.34.01	8	20	25	6	6	35	2,5	7,5	18	5	34 

Reference	Abmessungen - dimensions								Bemerkungen remarks remarques
	a	b	c	d	e	r1	r2	Bild	
07.29.01	80	30	30	11	5	5,5	15	1	29 
07.29.02	70	20	20	8	10	4	10	-	
07.29.03	115	60	30	-	6	6	30	-	
07.29.04	60	62	31	-	-	20	31	2	

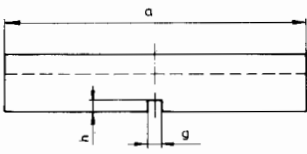
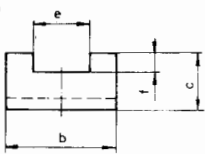
Reference	Abmessungen - dimensions								Bemerkungen remarks remarques
	a	b	c	d	e	f	g	w°	
07.32.01	120	24	16	13	2	4,5	7,5	15	32 
07.32.02	120	24	16	9	2	4	7	15	

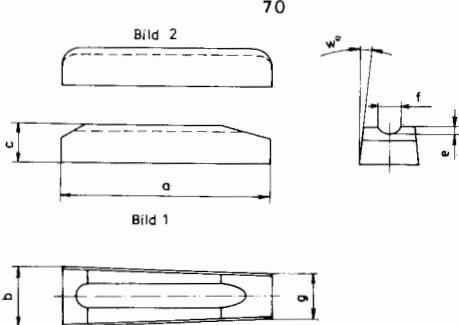
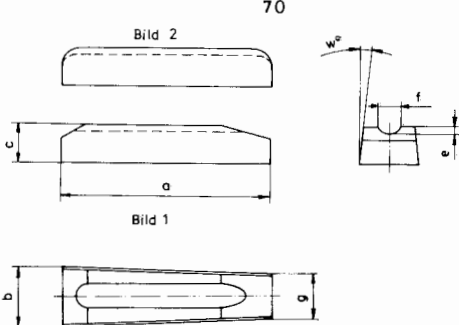
# Schleifstücke für Krane und Oberleitungsfahrzeuge

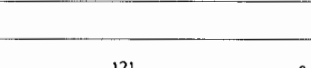
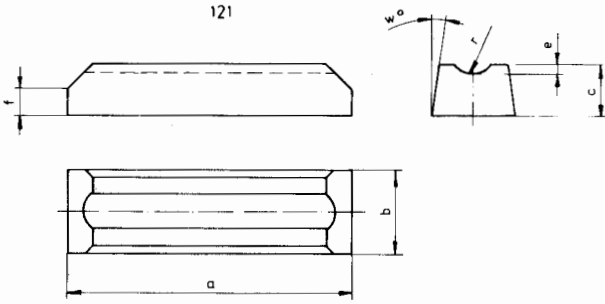
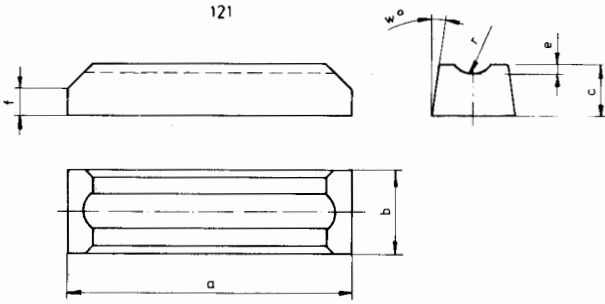
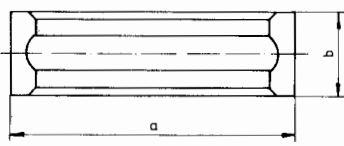
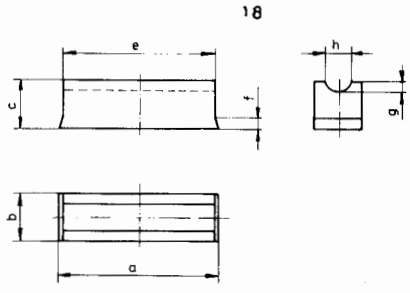
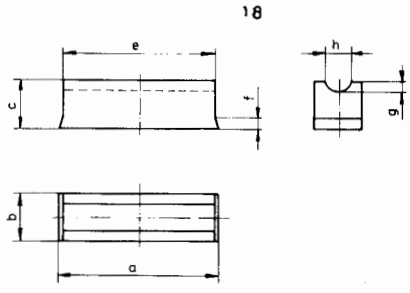
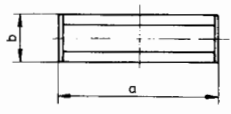
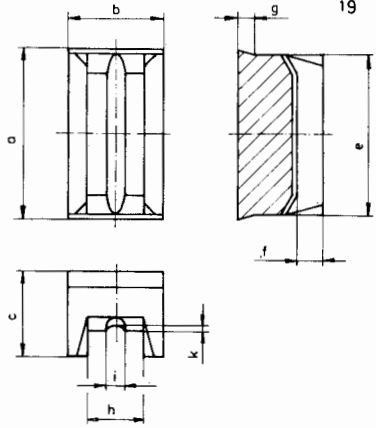
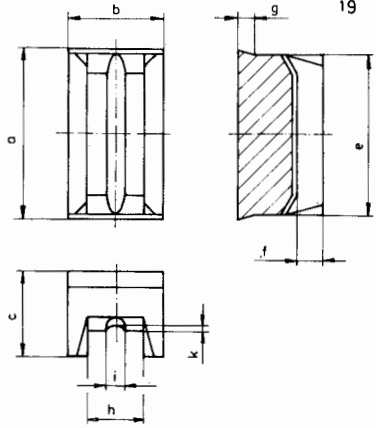
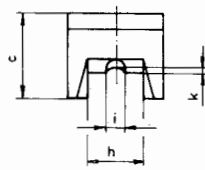
Reference	Abmessungen - dimensions								Bemerkungen remarks remarques			
	a	b	c	e	f	g	h	Bild				
07. 45. 01	160	60	36	30	10	7	6	1				
07. 45. 02	107	65	25	25	5	-	-	2				
										Bild 1		
										Bild 2		
Reference	Abmessungen - dimensions								Bemerkungen remarks remarques			
	a	b	c	e	f	g	w°	Bild				
07. 70. 01	90	26	16	8	16	21,5	3	2				
07. 70. 02	110	26	16	3	10	21	4	1				
07. 70. 03	110	26	16	2,5	12,5	20,3	4	1				
07. 70. 04	105	26,1	16	2,5	12,5	20,5	4	1				
07. 70. 05	110	26,1	16	2,5	12,5	21,5	4	1				
										Bild 1		
										Bild 2		
Reference	Abmessungen - dimensions								Bemerkungen remarks remarques			
	a	b	c	e	f	r	w°	Bild				
07. 121. 01	75	30	15	2	6	11	8					
												
Reference	Abmessungen - dimensions								Bemerkungen remarks remarques			
	a	b	c	e	f	g	h	Bild				
07. 18. 01	84	25	25	80	6	4,5	15					
												
Reference	Abmessungen - dimensions										Bemerkungen remarks remarques	
	a	b	c	e	f	g	h	i	k	Bild		
07. 19. 01	90	50	45	85	13	9	30	11	2			
												

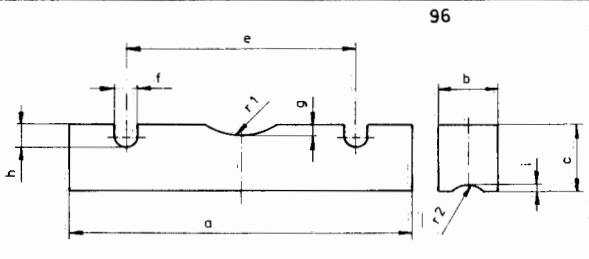
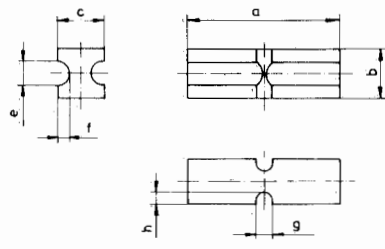
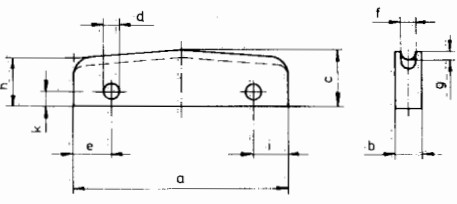
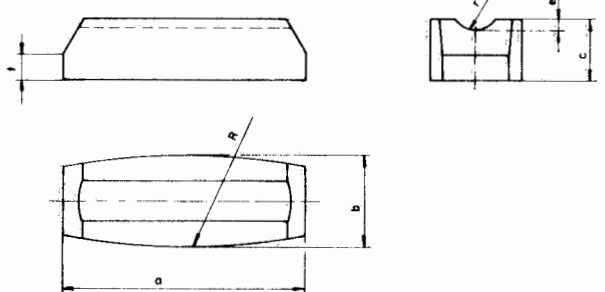
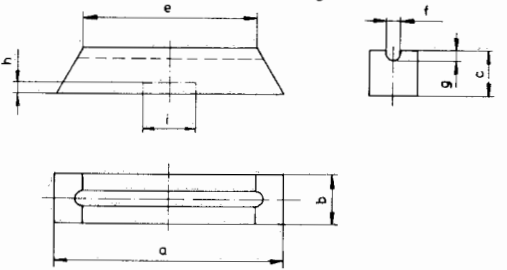
Reference	Abmessungen - dimensions								Bemerkungen remarks remarques	96		
	a	b	c	e	f	g	h	i				
07. 96. 01	180	32	35	121	12	6	12	3,5				
Reference	Abmessungen - dimensions							Bemerkungen remarks remarques	104			
	a	b	c	e	f	g	h					
07. 104. 01	80	25,5	24	12	6	7,5	6,5	verkupfert				
Reference	Abmessungen - dimensions										Bemerkungen remarks remarques	27
	a	b	c	d	e	f	g	h	i	k		
07. 27. 01	113	14	29	8,5	20,5	8	4	25	17,5	7		
Reference	Abmessungen - dimensions							Bemerkungen remarks remarques	126			
	a	b	c	e	f	r	R					
07. 126. 01	74	25,8	19	3	8	7,5	254					
Reference	Abmessungen - dimensions								Bemerkungen remarks remarques	15		
	a	b	c	e	f	g	h	i				
07. 15. 01	100	16	16	82	r=10	2	-	-				
07. 15. 02	100	16	17	82	5	2	-	-				
07. 15. 03	100	16	16	80	8	3	-	-				
07. 15. 04	80	35	16	48	12	2	5	22				
07. 15. 06	100	15,5	16,5	82	r=10	2	-	-				
07. 15. 07	100	24	18	80	9	1,5	-	-				
07. 15. 10	102	16	17	82	8	4	-	-				
07. 15. 11	107	65	25	-	25	5	-	-				
07. 15. 12	75	28	18	-	14,5	4	-	-				
07. 15. 13	42,5	16	24,5	-	5	2,5	-	-				

# Schleifstücke für Krane und Oberleitungsfahrzeuge

Reference	Abmessungen - dimensions							Bemerkungen remarks remarques				
	a	b	c	d	e	f	g					
07. 50. 01	90	20	25	7,5	6	25	1,5	verk., Bügel gelötet				
07. 50. 02	90	15	25	7,5	6	25	1,5	verk., Bügel gelötet				
07. 50. 03	90	15	25	10	5	25	1,5	verk., Bügel gelötet				
Reference	Abmessungen - dimensions									Bemerkungen remarks remarques		
	a	b	c	d	e	f	g	h	r			
07. 61. 01	200	30	40	6,5	10	150	18	5	-	Anlaufschräge 20°		
07. 61. 03	220	30	40	-	-	-	-	-	12			
Reference	Abmessungen - dimensions						Bemerkungen remarks remarques					
	a	b	c	e	f	r						
07. 60. 01	115	32	22	18	101	100						
Reference	Abmessungen - dimensions								Bemerkungen remarks remarques			
	a	b	c	e	f	g	h	Bild				
07. 63. 01	175	44	20	15	38	-	-	1	1/2 verkupfert  $w^\circ = 30^\circ$  $w^\circ = 15^\circ$ ohne Schraube $w^\circ = 30^\circ$ ohne Schraube			
07. 63. 02	430	24	15	7,5	18	10	3,5	2				
07. 63. 03	375	40	23,5	13	33	8,5	4	3				
07. 63. 04	103	35	25,5	20	30	-	-	3				
07. 63. 05	233	35	30	24,5	30	-	-	3				
07. 63. 06	150	35	25	20	30	-	-	1				
Reference	Abmessungen - dimensions										Bemerkungen remarks remarques	
	a	b	c	d	e	f	g	h	i	k		
07. 65. 01	60	24	26	M 5	38	8,5	10	9	9	3	1/2 verkupfert	
07. 65. 02	60	24	25,5	M 6	38	8,5	10	9	10,5	5	1/2 verkupfert	

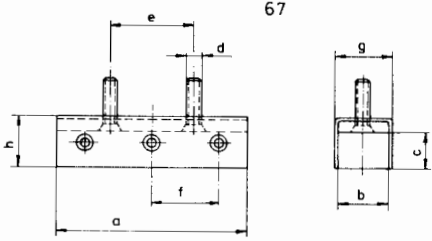
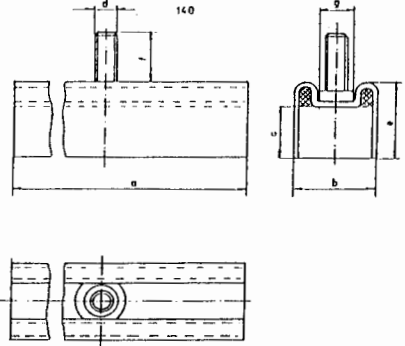
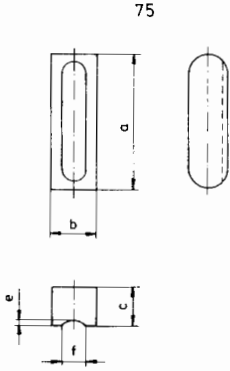
Reference	Abmessungen - dimensions								Bemerkungen remarks remarques	
	a	b	c	d	e	f	g	h		
07. 67. 01	100	26	19	M 8	45	35	30	26	MS Einlage und Cu-Bügel MS Einlage und Cu-Bügel	
07. 67. 02	120	26	19	M 8	45	45	30	26		
Reference	Abmessungen - dimensions							Bemerkungen remarks remarques		
	a	b	c	d	e	f	g			
07. 140. 01	100	26	19	M8	28	18	14			
Reference	Abmessungen - dimensions					Bemerkungen remarks remarques				
	a	b	c	e	f					
07. 75. 01	72	23	19	3	12					
07. 75. 02	72	20	19	1,5	9,5					

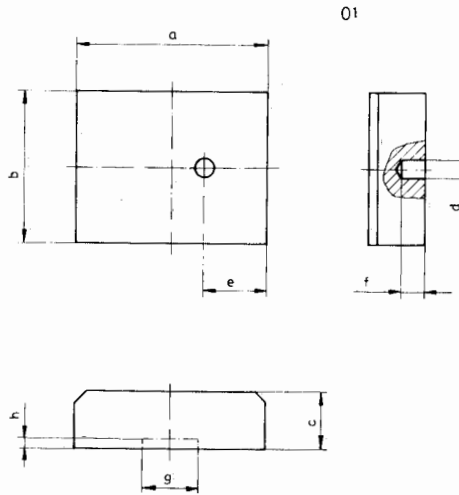
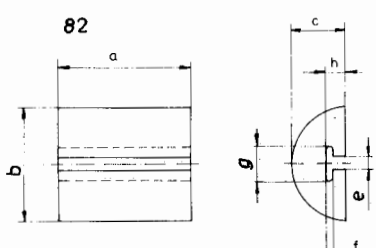
Reference	Abmessungen - dimensions								Bemerkungen remarks remarques	
	a	b	c	d	e	f	g	h		
07.01.01	140	80	30	11	24	8	-	-		
07.01.02	100	80	20	-	-	-	-	-		
07.01.03	135	100	30	10	34	3	-	-		
07.01.04	140	80	30	10	70	13	-	-		
07.01.05	140	100	30	10	70	13	-	-		
07.01.06	140	105	30	10	70	10	-	-		
07.01.07	140	80	30	8,5	25	5	-	-		
07.01.08	140	80	30	8,5	70	7,5	-	-		
07.01.09	95	64	18	-	-	-	-	-		
07.01.10	140	80	30	-	-	-	-	-		
07.01.12	125	100	30	-	-	-	-	-		
07.01.13	140	50	30	-	-	-	-	-		
07.01.14	125	100	35	-	-	-	-	-		
07.01.15	140	100	30	10	33	3,5	-	-		
07.01.16	140	70	30	11	24	8	-	-		
07.01.17	100	80	20	8	50	9	-	-		
07.01.19	130	95	30	-	-	-	-	-		
07.01.20	95	107	35	-	-	-	-	-		
07.01.21	95	90	35	-	-	-	-	-		
07.01.22	125	100	35	-	-	-	30	5,5		
07.01.23	140	30	50	-	-	-	-	-		
07.01.24	200	90	30	-	-	-	-	-		
07.01.25	200	110	35	-	-	-	-	-		
07.01.27	90	100	35	-	-	-	-	-		
07.01.28	100	80	40	-	-	-	-	-		
07.01.29	100	50	20	-	-	-	-	-		
07.01.30	140	80	30	8,5	25	5,5	-	-		
07.01.31	95	90	30	-	-	-	-	-		
07.01.32	140	50	30	M 10	70	16	-	-		
07.01.33	120		20	-	-	-	-	-		
07.01.34	140	50	30	10/9	70	30	-	-		
07.01.35	140	50	30	9,5	70	12	-	-		
07.01.36	100	50	20	9,5	50	3,5	-	-		
										<p>eine Anlaufkante R9 (Wendesleifst.)</p> <p>1/2 verkupfert</p> <p>Lauffläche Kanten- bruch 7 x 45°</p> <p>4 Bohrungen d = 16/9</p> <p>seitliche Rille R5</p> <p>4 Kanten abgerundet</p>
Reference	Abmessungen - dimensions							Bemerkungen remarks remarques		
	a	b	c	e	f	g	h			
07.82.01	70	50	24	5,5	4	16,5	9,5			

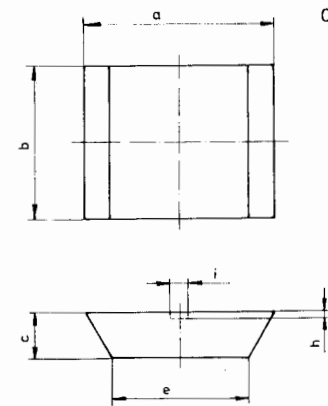

Reference	Abmessungen - dimensions						Bemerkungen remarks remarques	
	a	b	c	e	i	h		
07.03.01	150	110	30	110	-	-	 <p>03</p>	
07.03.02	140	76	30	120	-	-		
07.03.03	100	80	22	82	-	-		
07.03.04	100	110	18	86	-	-		
07.03.05	150	54	30	110	-	-		
07.03.06	100	210	20	85	-	-		
07.03.07	100	16	18	80	-	-		
07.03.08	140	80	30	120	-	-		
07.03.09	100	80	18	86	3,5	3		
07.03.10	125	115	20	110	-	-		4 Bohrungen d = 16/8
07.03.12	80	100	30	58	-	-		
07.03.13	140	140	30	120	-	-		
07.03.14	180	90	25	150	-	-		1/2 verkupfert
07.03.15	75	40	22	65	-	-		1/2 verkupfert
07.03.16	100	80	18	86	-	-		
07.03.17	100	80	25	80	4,2	4		Fläche verk., 4 Boh- rungen m. Gew. M8
07.03.18	80	80	30	60	-	-		
07.03.19	94	100	25	70	-	-		halb verkupfert
07.03.20	100	150	20	85	-	-		mit Nut d = 3,5x3,5
07.03.21	100	80	18	86	-	-		
07.03.22	180	90	25	~150	8	5		
07.03.23	140	120	30	115	-	-		

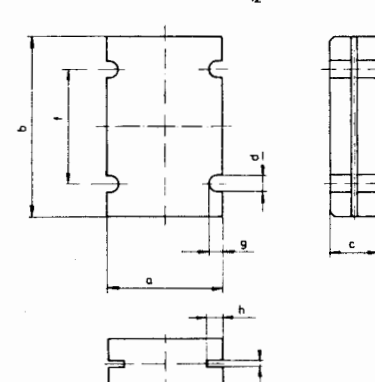
Reference	Abmessungen - dimensions								Bemerkungen remarks remarques
	a	b	c	d	e	f	g	h	
07.12.01	70	110	30	14	-	70	4,5	-	 <p>12</p>
07.12.02	80	140	30	10	4	80	7,5	10	
07.12.03	70	110	30	8	-	70	6	-	
07.12.04	85	130	25	18	-	80	13	-	
07.12.05	70	110	30	9	-	67	5	-	

Reference	Abmessungen - dimensions						Bemerkungen remarks remarques
	a	b	c	e	f	r	
07.120.01	16	50	20	9	12	45	*) 1/2 verkupfert
07.120.02	30	50	23	8	24	25	*)
07.120.03	16	50	20	9	12	40	*) 1/2 verkupfert
07.120.04	54	100	36	11	45	150	*) Kontakte

Reference	Abmessungen - dimensions								Bemerkungen remarks remarques
	a	b	c	e	f	g	h	i	
07.04.01	42,5	96	23	6	37	33	-	-	1/2 verkupfert
07.04.02	42,5	103	23	6	37	33	-	-	1/2 verkupfert
07.04.03	140	80	30	8,5	140	130	-	-	
07.04.04	140	100	30	12,5	138,5	122	-	-	
07.04.05	140	80	30	12	140	132,5	-	-	
07.04.06	140	120	30	13	140	131	-	-	
07.04.07	140	50	30	8	140	130	-	-	
07.04.08	140	100	30	8	140	130	-	-	
07.04.09	100	50	20	6	100	93	-	-	
07.04.10	70	34	24	7	70	64	-	-	
07.04.11	140	100	30	8,5	140	129	-	-	
07.04.12	125	100	35	11	125	120	-	-	
07.04.13	80	100	30	12	80	72	-	-	
07.04.14	80	120	30	12	80	70	-	-	
07.04.15	125	100	35	13	125	120	-	-	
07.04.16	80	60	30	12,5	80	79	-	-	
07.04.17	69	34	24	6	69	63	-	-	
07.04.19	140	100	30	8	140	130	-	-	2 Bohrungen d = 12 x 11
07.04.20	125	99	35	12	125	120	-	-	
07.04.21	100	50	30	8,5	100	92	-	-	
07.04.22	140	100	30	12,5	138	122	-	-	
07.04.23	80	80	30	12	80	74	-	-	
07.04.24	125	100	35	11	123,5	120	-	-	
07.04.25	100	50	20	9	100	92	-	-	
07.04.26	140	80	30	12	140	132	-	-	
07.04.27	140	100	30	8	136	127	-	-	
07.04.28	100	50	20	6	98	92	-	-	
07.04.30	100	80	30	12	100	88	-	-	
07.04.31	80	60	30	12	80	72	-	-	
07.04.32	80	94	30	12	80	72	-	-	
07.04.33	100	80	30	8	60	50	-	-	
07.04.34	140	100	30	12	140	132	-	-	
07.04.35	80	70	30	12	80	72	-	-	
07.04.36	80	100	30	12	80	72	-	-	
07.04.37	140	120	30	13	140	131	-	-	
07.04.39	40	200	19	5	36,7	33	-	-	mit Blecheinfassung
07.04.40	140	100	30	12,5	140	128	-	-	
07.04.41	100	100	30	14	100	88	-	-	
07.04.42	100	80	20	6	100	93	-	-	
07.04.43	140	80	30	8	140	128	-	-	

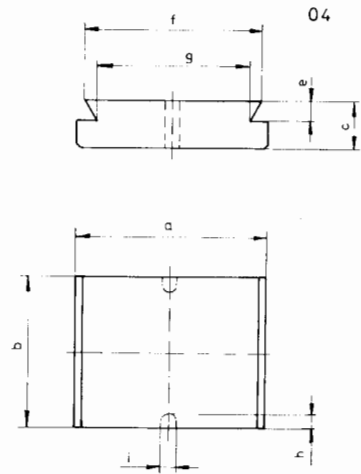

Reference	Abmessungen - dimensions								Bemerkungen remarks remarques
	a	b	c	e	f	g	h	i	
07. 04. 44	130	48	30	15	106	90	-	-	
07. 04. 45	140	100	30	9	140	128	-	-	
07. 04. 46	140	80	30	10	140	124	-	-	
07. 04. 47	125	90	25	11	122	118	-	-	
07. 04. 48	80	140	30	12	80	72	8,5	7	
07. 04. 49	140	100	30	12	140	132	-	-	
07. 04. 50	100	50	20	10	100	92	-	-	
07. 04. 51	140	100	30	12	140	130	-	-	
07. 04. 52	140	80	30	12	139,5	128	-	-	
07. 04. 53	80	80	30	12	79,3	-	-	-	
07. 04. 54	125	100	30	12	125	119	-	-	
07. 04. 55	140	120	30	12	140	-	-	-	

Reference	Abmessungen - dimensions							Bemerkungen remarks remarques
	a	b	c	e	f	g	h	
07. 129. 01	100	64	32	56	45	48	13	

Reference	Abmessungen - dimensions								Bemerkungen remarks remarques
	a	b	c	e	f	g	h	i	
07. 07. 01	100	80	37	8	60	-	-	-	
07. 07. 03	100	80	35	7	60	-	-	-	
07. 07. 04	100	78	30	8	60	-	-	-	
07. 07. 05	90	140	30	10	80	6,5	5	101,5	
07. 07. 06	80	80	35	8	60	-	-	-	

Reference	Abmessungen - dimensions										Bemerkungen remarks remarques	
	a	b	c	e	f	g	h	i	k	l		
07. 08. 01	110	95	32	100	64	50	10	7,5	3,5	60	1/2 verkupfert	
07. 08. 02	110	95	32	100	60	50	10	8	5	60	1/2 verkupfert	
07. 08. 03	80	95	32	70	40	30	10	7	3,5	61	1/2 verkupfert	
07. 08. 04	80	110	32	70	55	45	10	7,5	4	42	1/2 verkupfert	
07. 08. 05	160	85	32	150	112	100	10	7	3,5	60	1/2 verkupfert	
07. 08. 06	110	95	30	100	60	50	10	6	3	60		
07. 08. 07	160	95	32	150	112	100	10	9	4,5	60	1/2 verkupfert	

Reference	Abmessungen - dimensions									Bemerkungen remarks remarques	
	a	b	c	d	e	f	g	h	Bild		
07.09.01	200	80	30	d=12	10	130	55	5,5	1		
07.09.03	180	80	25	-	15	140	-	-	2		
07.09.04	180	100	25	-	15	140	-	-	2		
07.09.05	160	130	30	-	15	110	-	-	2		

Reference	Abmessungen - dimensions						Bemerkungen remarks remarques	
	a	b	c	f	r	Bild		
07.10.01	95	107	35	-	7	1	eine Fl. verzinkt	
07.10.02	100	140	30	-	-	1		
07.10.03	95	105	35	-	8	1		
07.10.04	80	80	30	-	-	1		
07.10.05	110	50	20	-	-	1		
07.10.06	100	80	40	3,5	5	2		

Reference	Abmessungen - dimensions							Bemerkungen remarks remarques	
	a	b	c	d	e	f	g		
07.11.01	80	140	30	11	20	50	15		
07.11.02	100	160	40	21/ 10,5	20	120	40		
07.11.05	95	117	35	M 10	23,5	70	35		
07.11.06	95	107	35	M 10	18	71	35		
07.11.08	100	140	30	11	20	50	15		
07.11.09	80	120	30	M 10	25	70	20		

Reference	Abmessungen - dimensions									Bemerkungen remarks remarques	
	a	b	c	d	e	f	g	h	Bild		
07.17.01	160	100	27	18	5	20	105	108	1	verk.	
07.17.03	81	35	14	9	3	9	48,5	56	1	verk.	
07.17.04	81	50	14	8	3	9	48,5	56	1	verk.	
07.17.05	81	35	23	8	3	18	48,5	50	1	verk.	
07.17.06	127	80	20	14	5	15	77	90	1	verk.	
07.17.07	127	120	20	14	5	15	77	90	1	verk.	
07.17.10	81	35	14	8	3	9	58	55	2	mit Bügel	
07.17.11	80	35	16,5	-	-	11,5	22	50	3	verk.	

Reference	Abmessungen - dimensions							Bemerkungen remarks remarques
	a	b	c	d	e	f	g	
07. 54. 01	80	35	16	M 6	20	27	27,5	
07. 54. 02	79,4	50	16,5	M 6	20	23,5	23,5	

54

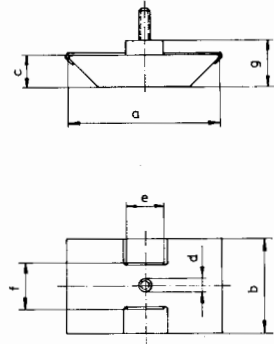

Reference	Abmessungen - dimensions					Bemerkungen remarks remarques
	a	b	c	d	e	
07. 26. 01	120	70	25	8,5	7,5	
07. 26. 02	100	80	30	7	7	

26

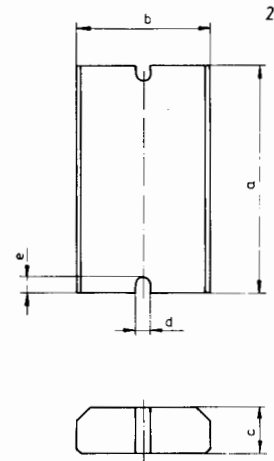

Reference	Abmessungen - dimensions						Bemerkungen remarks remarques
	a	b	c	e	f	g	
07. 55. 01	130	100	35	10	12	60	

55

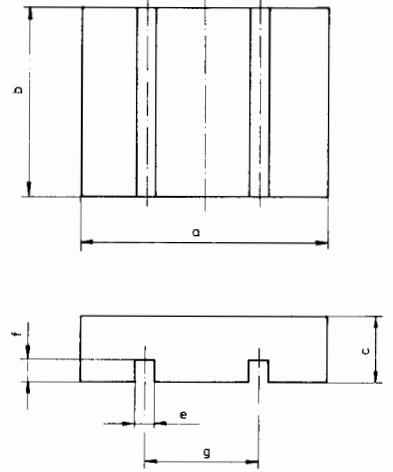

Reference	Abmessungen - dimensions							Bemerkungen remarks remarques
	a	b	c	d	e	f	g	
07. 95. 01	83	122	20	M 8	100	12	80	

95

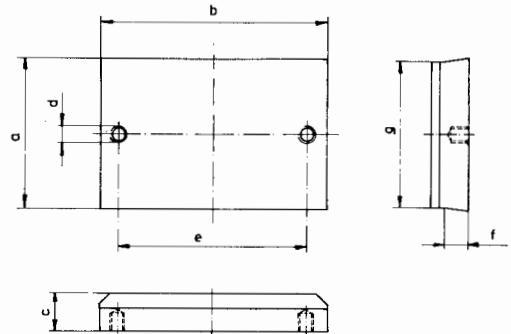

Plattenförmige Schleifstücke für Stromabnehmer

Reference	Abmessungen - dimensions							Bemerkungen remarks remarques	97
	a	b	c	e	f	d1	d2		
07. 97. 01	150	80	16	110	40	8,5	22		
Reference	Abmessungen - dimensions						Bemerkungen remarks remarques	128	
	a	b	c	d	e	f			
07. 128. 01	122	63	16	M8	30	6			
Reference	Abmessungen - dimensions						Bemerkungen remarks remarques	13	
	a	b	c	e	f	Bild			
07. 13. 01	139	100	30	131	6	1	Wende-Lauffläche		
07. 13. 02	140	80	40	130	23	2			

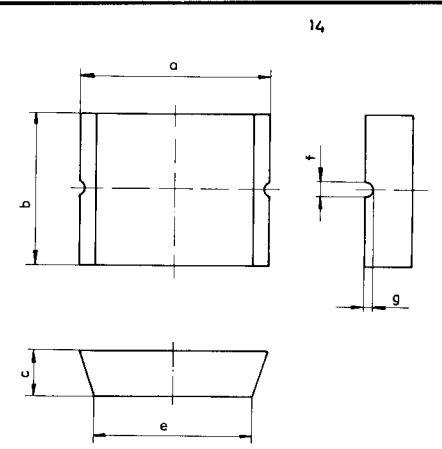
Reference	Abmessungen - dimensions						Bemerkungen remarks remarques	14 
	a	b	c	e	f	g		
07. 14. 01	100	80	18	86	3,5	3,5	Fl. verk.	
07. 14. 02	100	80	20	86	3,5	3,5		
07. 14. 03	100	160	18	86	3,5	3,5		
07. 14. 04	100	210	18	86	4	3		
07. 14. 05	100	80	25	81	3,5	3,5		

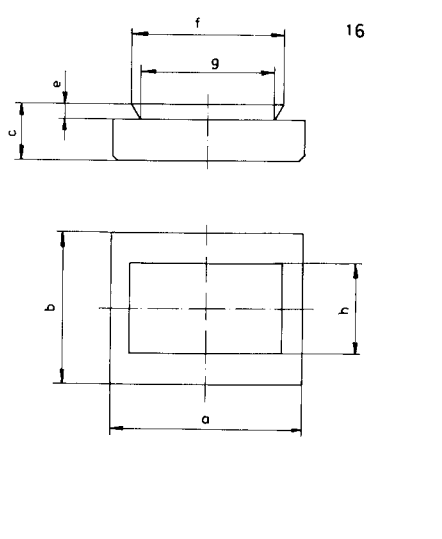
Reference	Abmessungen - dimensions							Bemerkungen remarks remarques	16 
	a	b	c	e	f	g	h		
07. 16. 01	80	100	35	8	79,5	75,5	60		
07. 16. 02	80	100	35	8	79	74	60		
07. 16. 03	200	100	30	8	80	75	60		
07. 16. 04	100	80	20	8	60	52	80		
07. 16. 05	100	80	30	8	60	52	80		
07. 16. 06	80	100	35	8	79	75,5	60		
07. 16. 07	150	100	35	8	79	74	60		
07. 16. 08	80	100	30	8	79,5	75,5	60		
07. 16. 09	100	80	35	8	79,5	75,5	60		
07. 16. 10	125	80	30	10	100	91	50		

Reference	Abmessungen - dimensions									Bemerkungen remarks remarques
	a	b	c	e	f	g	h	L	Bild	
07.28.01	140	100	30	50	7,5	3	12	110	1	
07.28.02	100	100	30	50	8	4	12	90	1	
07.28.03	160	100	30	50	7,5	3	12	120	1	
07.28.04	80	70	25	40	8	7	6	64	2	
07.28.05	80	70	25	35	9	7	8	75	2	
07.28.06	100	100	30	50	8	7	12	120	4	
07.28.07	140	100	30	50	8	7	12	115	4	
07.28.08	120	100	30	52	8	7	10	123	4	
07.28.09	140	100	30	52	8,5	7,5	11	115	4	
07.28.10	100	100	30	50	-	-	12	115	4	Gew. M10x12 mitte
07.28.11	100	100	40	52	8	7	10	120	1	
07.28.12	120	100	40	52	8	7	10	120	1	
07.28.13	140	100	30	50	-	-	12	180	4	Gew. M10x14 mitte
07.28.14	80	70	25	40	8,5	7,5	7	70,5	2	
07.28.15	120	70	30	52	8	7	10	115	4	
07.28.16	78	70	25	40	8,5	7	8	80	3	
07.28.17	80	70	25	40	8	7	12,5	65	2	
07.28.18	100	100	30	52	7	8	10	120	1	
07.28.19	120	100	30	54	7	7	10	130	4	
07.28.20	130	100	30	52	8	8	10	120	4	
07.28.21	160	100	30	53	8	7	10	150	4	
07.28.22	80	70	25	40	8,5	7	12,5	72	2	
07.28.23	120	100	30	52	7,5	4	12	123	1	
07.28.24	100	100	30	50	8	7	10	100	4	
07.28.25	80	70	25	35	9	7	8	80	4	
07.28.26	100	100	30	52	7	8	10	115	4	
07.28.27	65	100,3	30,3	54	7	8	10	115	4	
07.28.28	80	69,8	25	40	8	7	8	60	2	
07.28.29	100	100	30	52	8	7	10	100	4	
07.28.30	104	100	30	52	8	7	12	110	2	
07.28.31	100	100	30	52/77	8	8	10		5	

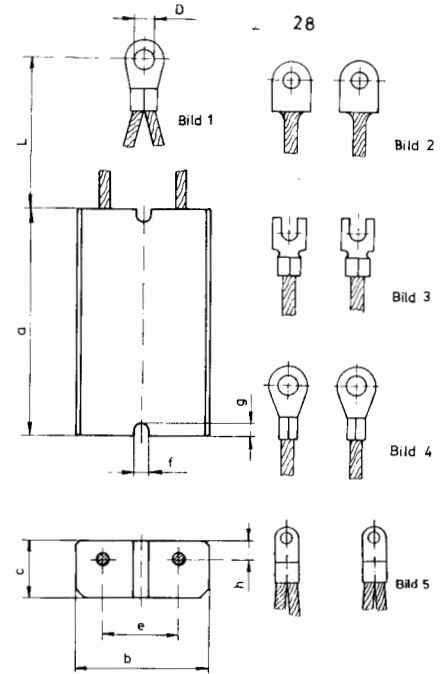



Reference	Abmessungen - dimensions								Bemerkungen remarks remarques
	a	b	c	d	e	f	L	D	
07. 56. 01	100	70	25	8	7	15	96	8,5	
07. 56. 02	120	70	25	8	8	15	100	8,5	
07. 56. 03	80	70	25	7	9	15	85	8,5	

Reference	Abmessungen - dimensions							Bemerkungen remarks remarques
	a	b	c	d	e	f	g	
07. 130. 01	151	70	30	9	60	5	5	

# Plattenförmige Schleifstücke mit Kabel für Stromabnehmer

Reference	Abmessungen - dimensions													Bemerkungen remarks remarques
	a	b	c	e	f	g	h	i	k	l	L	D	Bild	
07. 20. 01	160	100	30	78	60	7	4	80	9	7	115	9,5	1	
07. 20. 02	120	140	30	118	100	7	4	60	9,5	7	120	9	2	
07. 20. 03	105	86	30	64	40	7	4	60	8,3	7	110	9	1	
07. 20. 04	160	100	30	78	60	7	4	80	8,5	7	115	9	1	
07. 20. 05	160	172	30	150	130	7	10	80	9	7	160	11	1	
07. 20. 06	100	90	30	70	50	7	5	60	9	7	110	10,5	2	
07. 20. 07	100	110	30	90	25/50	7	5	60	9	8,5	110	10,5	2	
07. 20. 08	105	86	30	64	46	7	4	60	8,3	7	115	8	2	
07. 20. 10	100	110	30	90	50	7	4,8	60	8	8	105	10,5	2	
07. 20. 11	100	200	30	180	25/50	7	5	60	9	8,5	110	10,5	2	
07. 64. 01	100	48	30	3	9	6	8	25	10	115	8			
07. 74. 01	200	185	30	120	105	13	16	9,8	185	8,5				

Reference	Abmessungen - dimensions							Bemerkungen remarks remarques
	d	d1	l	c	D	D1	L	
07. 21. 01	94	75	34,6	22	22	18,2	34,6	MS Büchse

21

Reference Profil	Abmessungen - dimensions						Bemerkungen remarks remarques
	a	b	c	r	d1	d2	
P 0	53	48	-	7	11-18	-	auch ohne Bohrung
P 4	74	68	-	12	14-22	-	
P 5	60	54	-	7	10-18	-	
P 10	82	73	-	10	14-22	-	
07. 22. 15	60	54	17	7	16,5	5,5	mit MS Buchse
07. 22. 16	82	73	-	11	15	-	
07. 22. 17	77,5	70	-	9	16	-	
07. 22. 18	74,5	68	-	12	17	-	
07. 22. 19	63	63	-	30	17,5	-	

22

Maß "l" bei Bestellung angeben

Bild 2

Ausführung mit Keinut

Maße "e" und "f" bei Bestellung angeben

Reference	Abmessungen - dimensions						Bemerkungen remarks remarques
	a	b	d	r	D	Bild	
07. 23. 07	74	68	16	12	85	1	Schleifstücke mit Begrenzungsscheiben und eingietetem Messingrohr  weitere lieferbare Begrenzungsscheiben mit Durchmesser 75, 100 und 105 mm
07. 23. 08	75	68	18	12	85	1	
07. 23. 09	60	54	12	7	68	1	
07. 23. 10	60	54	16	7	68	1	
07. 23. 11	82	73	20	10	110	1	
07. 23. 14	82	73	16	10	85	1	
07. 23. 15	76	70	10	12	100	2	

23

Maß "l" bei Bestellung angeben

Bild 1

Bild 2

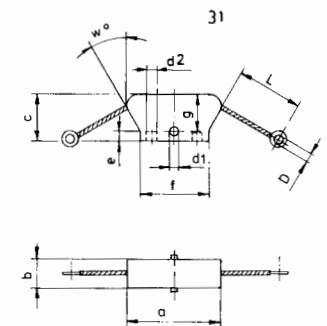
Reference	Abmessungen - dimensions											Bemerkungen remarks remarques	31 
	a	b	c	d1	d2	e	f	g	w°	L	D		
07. 31. 01	50	15	24	5	6	7	36	16,5	30	34	4,2	Konische Bohrung mitte d = 9	
07. 31. 02	50	15	24	6	8	6	36	16,5	30	34	4,2		
07. 31. 03	50	15	24	5	8	6	36	16,5	30	40	4,2		

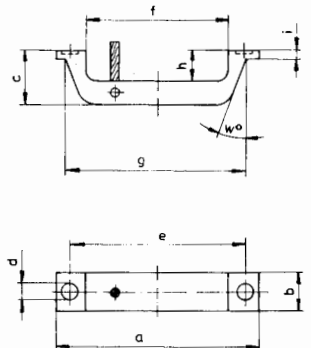
Reference	Abmessungen - dimensions											Bemerkungen remarks remarques	118 
	a	b	c	d	e	f	g	h	i	w°			
07. 118. 01	53,8	10	14	3,8	45,5	38	48	8	2	20	Cu Litze PVC isol. 300 lg		

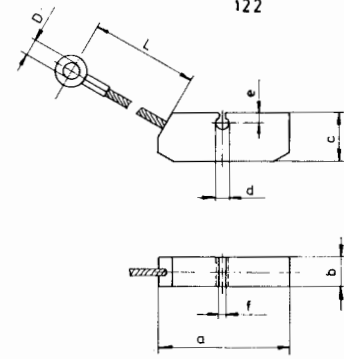
Reference	Abmessungen - dimensions								Bemerkungen remarks remarques	122 
	a	b	c	d	e	f	L	D		
07. 122. 01	34,5	7,5	12,5	3	2,5	2,2	35	4,3		

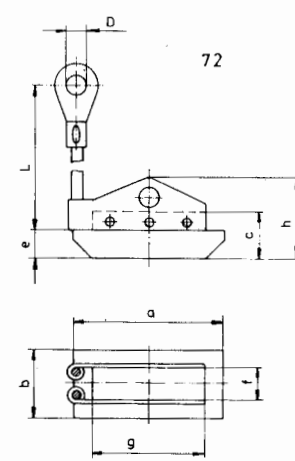
Reference	Abmessungen - dimensions									Bemerkungen remarks remarques	72 
	a	b	c	e	f	g	h	L	D		
07. 72. 01	80	35	25	15	16	60	42	235	10,4		
07. 72. 02	50	20	20	10	16	50	36	180	10,4		

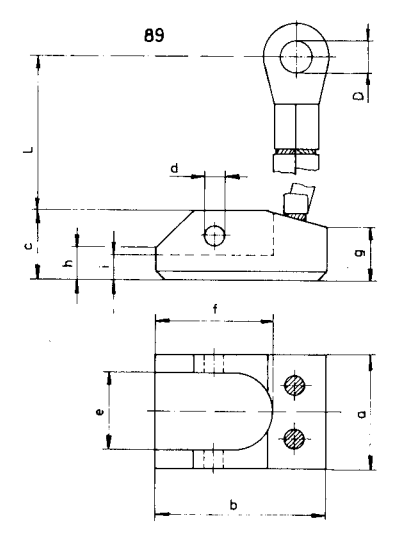
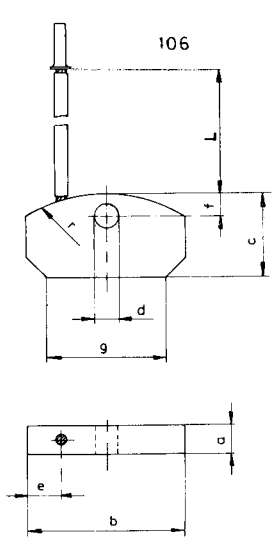
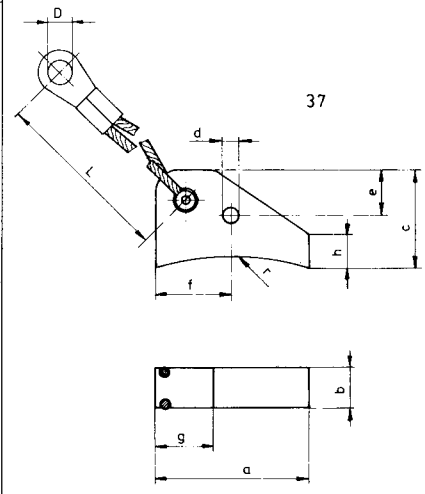
Reference	Abmessungen - dimensions											Bemerkungen remarks remarques	
	a	b	c	d	e	f	g	h	i	L	D		
07. 89. 01	30	45	18	5	20	31	13,5	8	6,5	150	7,5		
Reference	Abmessungen - dimensions									Bemerkungen remarks remarques			
a	b	c	d	e	f	g	r	L					
07. 106. 01	8	42	22	6	9	6	32	40	185	Endhülse			
Reference	Abmessungen - dimensions											Bemerkungen remarks remarques	
a	b	c	d	e	f	g	h	r	L	D			
07. 37. 01	80	19	52	8,5	23,5	41	30	18	145	199	12	isol. Litze	

Reference	Abmessungen - dimensions						Bemerkungen remarks remarques						
	a	b	c	d	e	f							
07. 134. 01	30	15	18	4	5,5	4							
Reference	Abmessungen - dimensions										Bemerkungen remarks remarques		
	a	b	c	d	e	f	g	h	r				
07. 107. 01	70	19	40	8,3	22	13	35	22	150				
Reference	Abmessungen - dimensions							Bemerkungen remarks remarques					
	a	b	c	d	e	f	g						
07. 142. 01	26	14	13	8,3	12	20	5,2						
Reference	Abmessungen - dimensions										Bemerkungen remarks remarques		
	a	b	c	d	e	f	L	D	Bild				
07. 85. 01	11,9	25,4	19	6,6	6,3	11,5	140	7	1				
07. 85. 02	25	35	20	6	4,5	7,5	110	6,4	2				

Reference	Abmessungen - dimensions											Bemerkungen remarks remarques	
	a	b	c	d	e	f	g	h	i	Bild	L		D
07. 53. 01	90	32	34	28	8,4	27	50	10	-	2	95	8,3	<p>Bild 1</p> <p>Bild 2</p>
07. 53. 02	90	34	43	28	11	36	58	10	70	1	80	6,5	
07. 53. 03	90	34	43	28	11	36	60	10	70	1	85	6,5	
07. 53. 04	99	37	43	-	-	-	-	-	69	1	93	6,5	

Reference	Abmessungen - dimensions								Bemerkungen remarks remarques	
	a	b	c	e	f	g	h	L		
07. 102. 01	43,5	9,8	11	53,5	19	8	2,5	235	Stiftkabelschuh	

Reference	Abmessungen - dimensions									Bemerkungen remarks remarques	
	a	b	c	d	e	f	g	r	L		
07. 88. 01	40	12	16	3	3	26	6	25	40	Bohreinfassung Litze isoliert	

# Schleifstücke und Kontakte für Kleinschleifleitungen



Reference	Abmessungen - dimensions								Bemerkungen remarks remarques	<div style="text-align: center;">103</div>	
	a	b	c	e	f	g	h	Bild			
07. 103. 01	47	4,9	14,5	3,65	12,5	2,2	8,3	1	Blechfassung		
07. 103. 02	140	6	30	4	-	-	8	2			
07. 103. 04	47,5	5	12,5	3,5	12,5	2,2	8,3	1			
07. 103. 05	189	8	46,5	3,5	-	-	8,5	3			
07. 103. 06	47	5	12,5	3,63	-	2,2	8	1			
Reference	Abmessungen - dimensions									Bemerkungen remarks remarques	<div style="text-align: center;">138</div>
a	b	c	d	e	f	g	h	r			
07. 138. 01	68	5	12,5	2,8	14	13	4,5	3,7	7	bronze	
07. 138. 02	68	5	14,6	2,8	14	13	4,5	3,7	7	schwarz	
Reference	Abmessungen - dimensions						Bemerkungen remarks remarques	<div style="text-align: center;">131</div>			
a	b	c	e	f	g						
07. 131. 01	50	3	15	3,2	0,7	1,5	Schutzleiter				
07. 131. 02	50	3	15	3,2	0,7	1,5					
07. 131. 04	56	3	19	3,5	1,8	-					
Reference	Abmessungen - dimensions									Bemerkungen remarks remarques	<div style="text-align: center;">150</div>
a	b	c	d	e	f	g	h	r			
07. 150. 01	55,5	5	30	6	3	6	45°	5°	190		

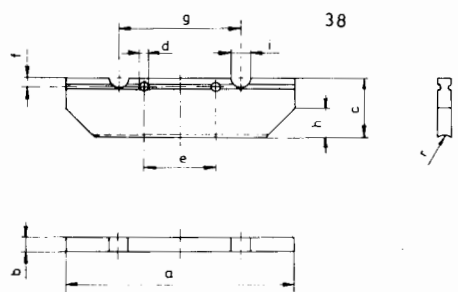
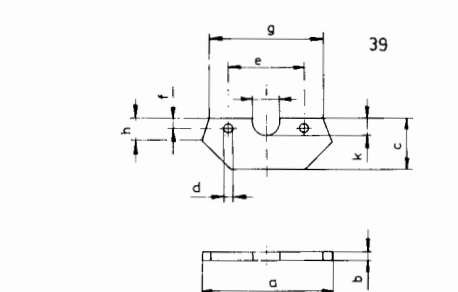
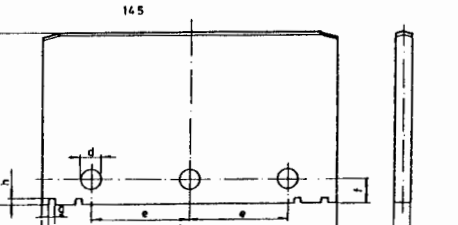
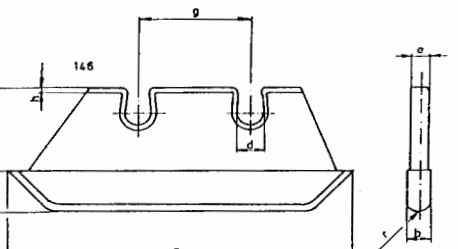
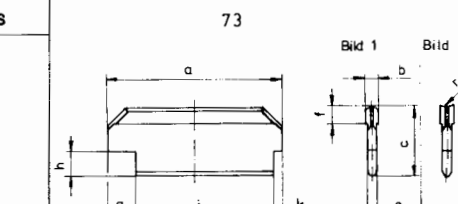

Reference	Abmessungen - dimensions										Bemerkungen remarks remarques		
	a	b	c	d	e	f	g	h	i	r			
07. 38. 01	120	7	25,5	5,2	38	4,25	62	8	8	5			
07. 38. 02	119,5	6,5	30	5	38,5	4,5	64	15	9,5	5			
Reference	Abmessungen - dimensions										Bemerkungen remarks remarques		
a	b	c	e	f	g	h	i	k	d				
07. 39. 01	67	5	25,5	41	4,5	60	12	14,5	9	5,2			
Reference	Abmessungen - dimensions								Bemerkungen remarks remarques				
a	b	c	d	e	f	g	h						
07. 145. 01	5	90	55	6,2	30	8	2	1,5					
Reference	Abmessungen - dimensions										Bemerkungen remarks remarques		
a	b	c	d	e	f	g	h	r					
07. 146. 01	53	4	20	3,95	2,9	6,5	17	4	2,5				
Reference	Abmessungen - dimensions											Bemerkungen remarks remarques	
a	b	c	e	f	g	h	i	k	r	Bild			
07. 73. 01	90	5	36	3,5	9	15	13	72	3	0	1		73 Bild 1 Bild 2
07. 73. 02	90	5	36	3,5	9	15	13	72	3	4,7	2		
07. 73. 03	160	7	63	5	15	36	24	119	5	-	1		

Reference	Abmessungen - dimensions								Bemerkungen remarks remarques	76				
	a	b	c	e	f	g	h	k						
07. 76. 01	73,5	5	36	3,5	9	1,5	13	10,5						
Reference	Abmessungen - dimensions							Bemerkungen remarks remarques	77					
	a	b	c	e	f	g	h							
07. 77. 01	160	7	58	5	10	32	24							
Reference	Abmessungen - dimensions									Bemerkungen remarks remarques	105			
	a	b	c	d	e	f	i	r						
07. 105. 01	100	4	32	5,3	50	8	69,5	20						
07. 105. 02	80	4	30	-	32	9	70	13	Blechfassung 2 Blechbügel					
Reference	Abmessungen - dimensions											Bemerkungen remarks remarques	86	
	a	b	c	d	e	f	g	h	i	w°	Bild			
07. 86. 01	82	5	31,5	-	-	64	71	13,5	35	-	1			
07. 86. 02	80,5	5	27	4,6	10,5	63,5	70,5	13	35	-	1			
07. 86. 03	105	5	31,5	-	-	96,4	71	13,5	35	-	1			
07. 86. 04	110	6	28	5	11	64	71	13	34,3	30	2			
07. 86. 05	100	18	25,5	5	10	63	70	13	-	45	~2			
Reference	Abmessungen - dimensions						Bemerkungen remarks remarques	Kohle mit Halter montiert						
	a	b	c	d	e	f								
07. 144. 01	50	4	33	6,3	38	14								

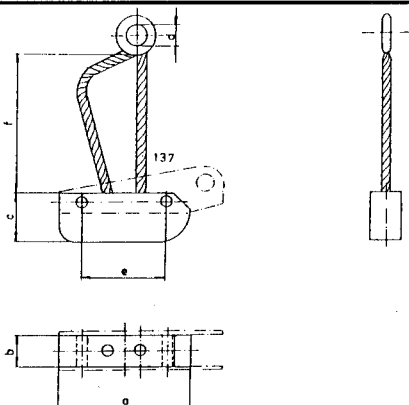
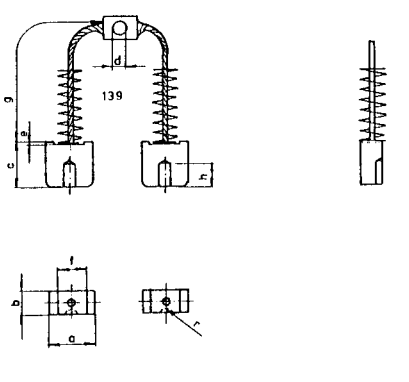
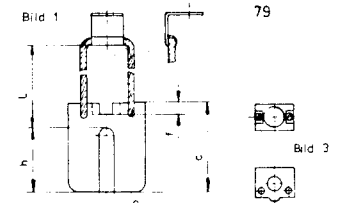
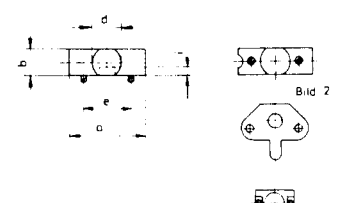
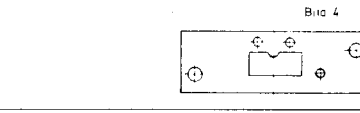
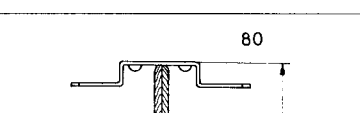
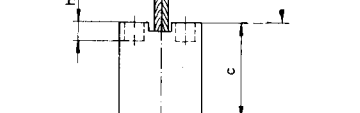
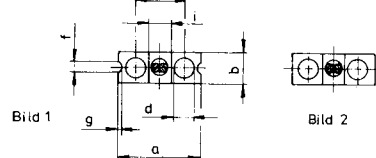
Reference	Abmessungen - dimensions									Bemerkungen remarks remarques		
	a	b	c	e	f	g	h	L	D			
07. 101. 01	32	8	19	3,5	6,4	8	13	58	3,4	Kompl. mit Halter		
07. 101. 02	32	8	19	3,5	6,4	8	13	58	3,4			
Reference	Abmessungen - dimensions							Bemerkungen remarks remarques				
	a	b	c	e	f	g	h					
07. 115. 01	25	8	20	5	2,5	16	60	mit Halter				
Reference	Abmessungen - dimensions									Bemerkungen remarks remarques		
	a	b	c	d	e	f	g	h	r			
07. 136. 01	24,5	8	17,5	2,1	6,4	5	14	15	2,5	Phase		
07. 136. 02	24,5	8	17,5	2,1	6,4	5	14	15	2,5	Nulleiter		
07. 136. 03	24,5	8	22	2,1	6,4	5	14	22	2,5	Phase		
07. 136. 04	24,5	8	22	2,1	6,4	5	14	22	2,5	Nulleiter		
Reference	Abmessungen - dimensions									Bemerkungen remarks remarques		
	a	b	c	d	e	f	g	h	r			
07. 149. 01	25	8	19	4	16	2	3	8	2,5	Nulleiter		
07. 149. 02	25	8	19	4	16	2	3	8	2,5	Phase		
07. 149. 03	25	8	24	4	16	2	3	8	2,5	Nulleiter		
07. 149. 04	25	8	24	4	16	2	3	8	2,5	Phase		
Reference	Abmessungen - dimensions									Bemerkungen remarks remarques		
	a	b	c	d	e	f	g	h	L			D
07. 117. 01	80	25	35	19	50	18	30	14	160	10,5	Rohrschuh 20 x 20	
07. 117. 02	80	25	35	20	50	15	30	13	160	10,5	Quetschkabel- schuh ohne Bügel	
07. 117. 03	80	25	35	16	50	20	-	-	75	9,5	ohne Bügel	
07. 117. 04	80	25	35	16,5	45	22	-	35	90	-	ohne Bügel	

Reference	Abmessungen - dimensions						Bemerkungen remarks remarques							
	a	b	c	d	e	f								
07. 137. 01	40	10	16	6,2	26	43								
Reference	Abmessungen - dimensions										Bemerkungen remarks remarques			
	a	b	c	d	e	f	g	h	r					
07. 139. 01	14	7	15	4,5	1	9	40	8	2	mit je 1 Nut				
07. 139. 02	14	7	15	4,5	1	9	40	8	2	mit je 2 Nuten				
07. 139. 03	14	7	15,5	4,3	1	9,5	40	9	-	geschlitzt 2,5 breit				
Reference	Abmessungen - dimensions											Bemerkungen remarks remarques		
	a	b	c	d	e	f	g	h	i	L	Bild			
07. 79. 01	24	8	27	8,5	14,5	4	5	19,5	2,5	35	1			
07. 79. 02	23	8	24	8,6	23	1,8	5	18	2,5	35	2			
07. 79. 03	12	8	22	6,5	-	1	d=4	15	-	27	3			
07. 79. 04	12	8	24	6	-	3	d=4,2	16	-	30	4			
07. 79. 07	23,3	5,5	24	8	15	2	3	11	-	34	3			
Reference	Abmessungen - dimensions											Bemerkungen remarks remarques		
	a	b	c	d	e	f	g	h	i	L	Bild			
07. 80. 01	22,5	8	25	5,5	13,5	3	1	5	6	25	1			
07. 80. 02	23	8	23	5	13,5	-	-	4,5	5,5	22	2			

Reference	Abmessungen - dimensions									Bemerkungen remarks remarques	
	a	b	c	e	f	g	h	i	Bild		
07. 44. 01	20	8	24	3,5	2	17	54	10	1	Nietlasche	
07. 44. 02	20	8	24	3,5	2	17	54	5	1		
07. 44. 03	20	8	24	3,5	2	17	54	5,25	1		
07. 44. 04	20	8	25	3,5	2	17	55	10	2		
07. 44. 06	20	8	25	3,5	2	17	55	5,25	2		
07. 44. 07	20	8	24	3,5	2	17	50	10	1		
07. 44. 08	20	8	25	3,5	2	17	51,5	5,25	2		
07. 44. 08	20	8	25	3,5	2	17	51,5	5,25	2		

Reference	Abmessungen - dimensions							Bemerkungen remarks remarques	
	a	b	c	d	e	f	g		
07. 108. 01	36	10	18	8,1	27	24	2,5	Stromleiter	
07. 108. 02	36	10	18	8,1	27	24	2,5	Nulleiter	

Reference	Abmessungen - dimensions						Bemerkungen remarks remarques	
	a	b	c	i	f	g		
07. 110. 01	36	10	18	8	24	2,5	Stromleiter	
07. 110. 02	36	10	18	8	24	2,5	Nulleiter	

Reference	Abmessungen - dimensions							Bemerkungen remarks remarques	
	a	b	c	e	r	g	h		
07. 123. 01	8	24,5	23	2,5	2,5	17	32		

Reference	Abmessungen - dimensions									Bemerkungen remarks remarques	
	a	b	c	d	e	f	g	h	r		
07. 147. 01	8	24,5	23	5,2	5	24,5	16	32	2,5		
07. 147. 02	8	24,5	19	5,2	5	24,5	15	32	2,5		
07. 147. 03	8	24,5	19	4,3	5	24,5	15	32	2,5		

Reference	Abmessungen - dimensions									Bemerkungen remarks remarques	Bild
	a	b	c	e	f	g	h	i	Bild		
07. 100. 01	5	23	24	15	-	-	-	-	1	Fangstift  gleiche Kohle 02 Graphit Marke gleiche Kohle 03 Graphit Marke  Fangstift	
07. 100. 02	5,5	23,3	24	16	2,5	2,5	15	1,5	1		
07. 100. 03	5,5	23,3	24	16	2,5	2,5	15	1,5	2		
07. 100. 04	-	-	-	-	-	-	-	-	1		
07. 100. 05	-	-	-	-	-	-	-	-	2		
07. 100. 06	7	23	24	12	-	-	-	-	1		
07. 100. 07	7	23	24	12	-	-	-	-	1		
07. 100. 08	5	23	24	15	-	-	-	-	2		
07. 100. 09	5	23	24	12	-	-	-	-	2		
07. 100. 10	5	22	24	12	-	-	-	-	1		
07. 100. 11	5	22	24	12	-	-	-	-	2		

Reference	Abmessungen - dimensions								Bemerkungen remarks remarques	Bild
	a	b	c	e	f	g	h	Bild		
07. 109. 01	20	8	25	3,5	2	19,5	51,5	1		
07. 109. 02	20	8	25	3,5	2	19,5	51,5	2		

Reference	Abmessungen - dimensions								Bemerkungen remarks remarques	Bild
	a	b	c	e	f	g	h	Bild		
07. 114. 01	24	9	25	4,5	2	21,5	48	1		
07. 114. 02	24,5	12	25	R 2,5	2,5	20	60	2		

Reference	Abmessungen - dimensions						Bemerkungen remarks remarques	Bild
	a	b	c	d	e	f		
07. 127. 01	25	8	19	7	4,5	2,2		

Reference	Abmessungen - dimensions											Bemerkungen remarks remarques
	a	b	c	e	f	g	h	k	r	i	L	
07. 111. 01	5,5	23,3	24	2,6	2,5	1,5	13,5	9	7	11	20	Phase Erde
07. 111. 02	5,5	23,3	24	2,6	2,5	1,5	13,5	9	7	3	27	

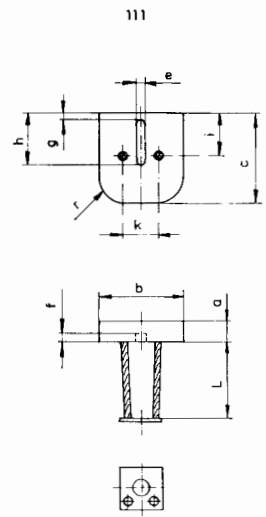

Reference	Abmessungen - dimensions											Bemerkungen remarks remarques
	a	b	c	d	e	f	g	h	L	D	Bild	
07. 49. 01	20	10	25	4,5	5,4	15,5	7,3	3	25	6,3	1	Erde
07. 49. 02	20	10	25	4	3,5	15	3,8	2	70	-	2	
07. 49. 03	20	10	25	4,8	4	20	3,5	2,5	70	-	2	
07. 49. 04	20	10	35	4	3,5	25	3,8	2	80	-	2	Phase
07. 49. 05	20	10	25	4	3,5	15	7,3	2	70	-	2	
07. 49. 06	20	10	25	4,8	4	20	8	2,5	70	-	2	
07. 49. 07	20	10	35	4	3,5	25	8,25	2	80	-	2	
07. 49. 08	20	10	25	4	5	15,5	3	3	23	6,3	1	
07. 49. 09	20	10	28,5	4,5	3,5	24	8,25	2	80	-	2	mit Schuh
07. 49. 10	20	10	28,5	4,6	3,5	24	3,5	2	80	-	2	
07. 49. 11	15	8	25	6	-	-	-	-	57	4,3	-	

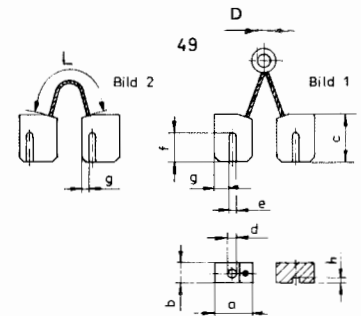

Reference	Abmessungen - dimensions											Bemerkungen remarks remarques
	a	b	c	d	e	f	g	h	i	L		
07. 90. 01	9,5	36	23	2	12,5	6,5	24	5	13	36/29	Endhülse u. Öse d = 6,5 Kabelöse d = 6,5	
07. 90. 02	9,5	36	23	2	12,5	6,5	24	5	13	27,5		

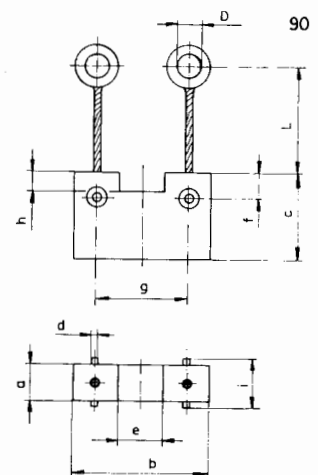

## Schleifstücke und Kontakte für Kleinschleifleitungen

Reference	Abmessungen - dimensions											Bemerkungen remarks remarques	
	a	b	c	d1	e	f	g	h	i	L	D		
07.125.01	25	8	20	6,2	15,2	6,5	15	14	10	60	4,6	Kabelöse Kabelöse Kabelöse, Fahnen- schuh Kabelöse, Fahnen- schuh Kabelöse, Fahnen- schuh	
07.125.02	25	8	20	6,2	15,2	5	15	14	10	60	4,6		
07.125.03	25	8	22	6,2	15,2	6,5	16	16	10	88	4,6		
07.125.04	25	8	26	6,2	15,2	6,5	19	16	10	60	4,6		
07.125.05	25	8	26	6,2	15,2	5	16	10	10	60	4,6		
07.125.06	25	8	22	6,5	15	-	16	-	8,5	72	5,2		

Reference	Abmessungen - dimensions										Bemerkungen remarks remarques	
	a	b	c	d	e	f	g	h	L	Bild		
07.112.01	25	8	18,5	6,5	16	5,5	8	11,5	34	1	Cu Einfassung 3° Kabelöse oder Fahnen- schuh Kabelöse oder Fahnen- schuh Fangstift d = 3 x 1 Schlitz 4x1 ohne Fangstift ohne Fangstift mit Fangstift mit Fangstift, Rohr- schuh ohne Fangstift, Rohrschuh mit Öse	
07.112.02	25	8	18,5	6,2	15,2	5	10	11	31	1		
07.112.03	25	8	18,5	6,2	15,2	6,5	10	11	45	1		
07.112.04	25	8	18,5	6,5	16	5,5	8	11,5	35	2		
07.112.05	25	8	18,5	6,5	16	5,5	8	11,5	35	3		
07.112.06	25	8	15,6	6,7	15	5,5	10	11,5	35	3		
07.112.07	25	8	15,6	6,7	15	5,5	10	11,5	35	3		
07.112.08	25	8	20	6,5	16	5	8	14	35	2		
07.112.09	25	8	18,5	6,3	15	5,5	10	11	37	2		
07.112.10	25	8	18,5	6,3	15	5,5	10	11	37	1		
07.112.11	25	8	18,5	6,3	16	7	8	11,5	37	1		

Reference	Abmessungen - dimensions								Bemerkungen remarks remarques	
	a	b	c	d1	d2	f	h	L		
07.116.01	7,95	16,1	19,1	3	6	5,5	5	140	Endhülse isol. braun/schwarz Endhülse isol. grün/gelb isol. grün/gelb isol. schwarz	
07.116.02	7,95	17,1	19,1	3	6	5,5	5	140		
07.116.03	8	27	19	3	6	5,5	5	150		
07.116.04	8	26	18	3	6,1	5,5	5	170		

Reference	Abmessungen - dimensions						Bemerkungen remarks remarques	
	a	b	c	e	r	L		
07.87.01	12,3	8,2	19	13	2,5	80	87	

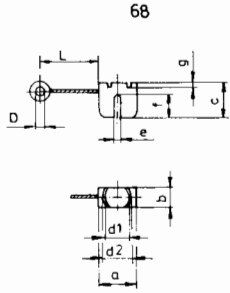
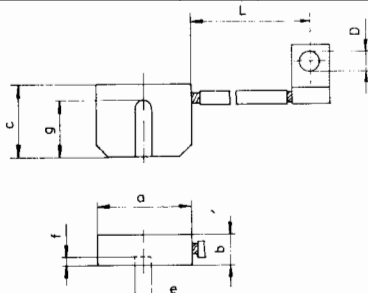
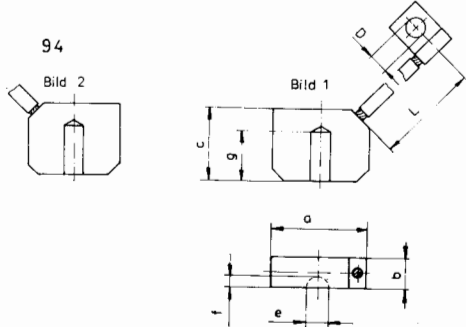
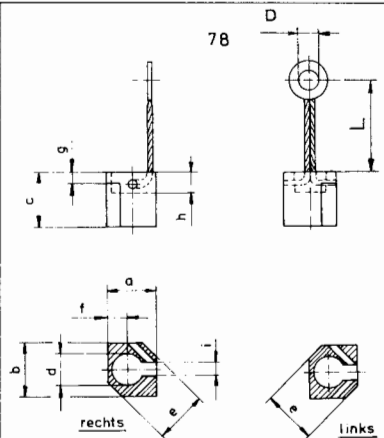

Reference	Abmessungen - dimensions										Bemerkungen remarks remarques		
	a	b	c	d1	d2	e	f	g	L	D			
07. 68. 01	16,5	8	15	10	14	2,5	10	3	30	5	Litze rechts		
07. 68. 02	16,5	10	15	10	14	2,5	10	3	30	5			
07. 68. 03	16,5	12	15	10	14	2,5	10	3	35	5			
07. 68. 04	20	10	18	8	10	2,5	12,5	4,5	35	5			
07. 68. 05	17	8	15,5	9,5	14,5	2,5	10,5	2,5	35	5			
07. 68. 06	16,5	8	15	10	14	2,7	10	3	35	5			
07. 68. 07	16,5	10	15	10	14	2,7	10	3	35	5			
07. 68. 08	17	12	15	10	14	2,7	10	3	35	5			
07. 68. 09	16,5	9,8	15	10	14	-	-	3	45	4			
07. 68. 10	16,5	7,8	15	10	14	-	-	3	45	5			
07. 68. 11	16,5	8	15	10	14	2,7	10	3	35	5			
07. 68. 12	16,6	7,8	15	10	14	2,5	10,7	3	33	5,3			
07. 68. 13	16,6	11,9	15	10	14	2,5	10,7	3	33	5,3			
07. 68. 14	16,6	9,8	15	10	14	2,5	10,7	3	33	5,3			
Reference	Abmessungen - dimensions								Bemerkungen remarks remarques	93			
	a	b	c	e	f	g	L	D					
07. 93. 01	24,5	8,35	19	5,5	3	15	56	5,3					
07. 93. 02	25	8	19	4	2	15	45	5,3					
Reference	Abmessungen - dimensions								Bemerkungen remarks remarques	94			
	a	b	c	e	f	L	D	Bild					
07. 94. 01	24,6	8,1	19	5,6	2,8	53	4,3	1					
07. 94. 02	24,6	8,1	19	5,6	2,8	53	4,3	2					
07. 94. 03	24,5	8	19	2,7 r	-	45	4,3	1					
07. 94. 04	24,5	8	19	5	2,5	50	5	2					
07. 94. 05	24,5	8,3	19	5	2,5	50	5	1					
Reference	Abmessungen - dimensions										Bemerkungen remarks remarques	78	
	a	b	c	d	e	f	g	h	i	L			
07. 78. 01	12,3	13,7	15	8,2	14,5	5	3	5	4,5	22,5	5	links  links links - rechts	
07. 78. 02	12,3	13,7	13	8,2	14,5	5	3	5,5	4	24	5,2		
07. 78. 03	12,3	13,7	15	8,2	14,5	5	3	5	4,5	22,5	5		
07. 78. 04	12,3	13,7	13	8,2	14,5	5	3	5,5	4	24	5,2		
07. 78. 05	12,3	13,7	15	8,2	14,5	5	3	5	4,5	22,5	5		
07. 78. 06	12,5	14	13	8,2	14,5	5	3	5,5	4	24	5,2		
07. 78. 07	12,5	14	13	8,2	14,5	5	3	5,5	4	24	5,2		

Reference	Abmessungen - dimensions							Bemerkungen remarks remarques							
	a	b	c	d	e	f	g								
07. 143. 01	15	12	20	d=6,5	8	5,5	3,5								
Reference	Abmessungen - dimensions										Bemerkungen remarks remarques				
	a	b	c	d	e	f	g	h	i	k					
07. 59. 01	30	12	9	3,5	20	22,5	2	30	28	20					
Reference	Abmessungen - dimensions												Bemerkungen remarks remarques		
	a	b	c	d1	d2	e	f	g	h	i	w°	k			
07. 71. 01	32	16	18,5	5,2	3,2	8	8	M3	13,5	14,5	100	9,5			
Reference	Abmessungen - dimensions									Bemerkungen remarks remarques					
	a	b	c	d	e	f	g	r1	r2						
07. 84. 01	27	10	16,5	4,5	5	4,5	20	5	20						

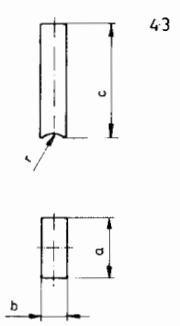
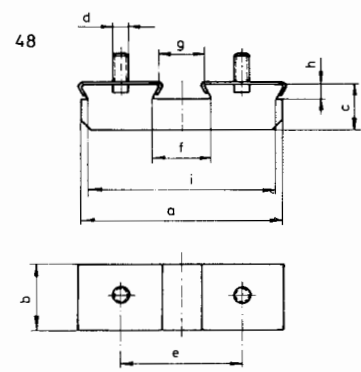
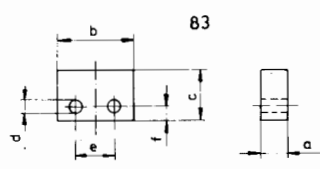
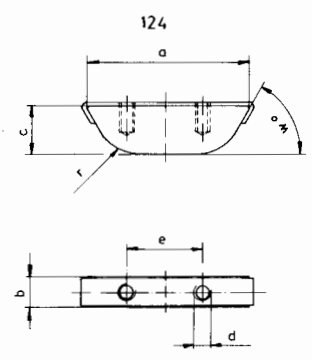
Reference	Abmessungen - dimensions				Bemerkungen remarks remarques					
	a	b	c	r						
07. 43. 02	32	15	60	8						
Reference	Abmessungen - dimensions									Bemerkungen remarks remarques
	a	b	c	d	e	f	g	h	i	
07. 48. 01	105	35	23,5	M8	64	29	23	7	98	
Reference	Abmessungen - dimensions						Bemerkungen remarks remarques			
	a	b	c	d	e	f				
07. 83. 01	6,4	19	13	3,1	10,5	4				
Reference	Abmessungen - dimensions							Bemerkungen remarks remarques		
	a	b	c	d	e	r	w°			
07. 124. 01	44	8	13	M4	20	12	60			

Reference	Abmessungen - dimensions							Bemerkungen remarks remarques	40
	a	b	c	d	r1	r2	Bild		
07. 40. 01	80	65	58	24	250	13,5	1		
07. 40. 02	80	50	29,5	15	-	50	2		

Reference	Abmessungen - dimensions						Bemerkungen remarks remarques	41
	a	b	c	d	h	r		
07. 41. 01	65	30	58	M10	22	15		

Reference	Abmessungen - dimensions								Bemerkungen remarks remarques	42
	a	b	c	d	e	f	h	r		
07. 42. 01	65	30	58	M10	35	25	22	15		

Reference	Abmessungen - dimensions							Bemerkungen remarks remarques	113
	a	b	c	e	f	g	Bild		
07. 113. 01	35	30	20	18	15	1,5	1		
07. 113. 02	30	40	18	18	10	1,5	1		
07. 113. 03	45	30	20	18	31	7	2		
07. 113. 04	35	30	20	18	22	7	2		
07. 113. 05	35	30	18	18	-	-	3		

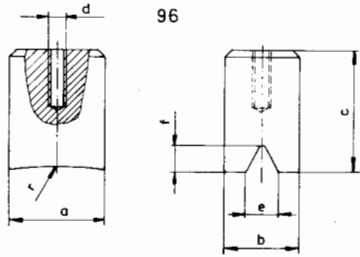
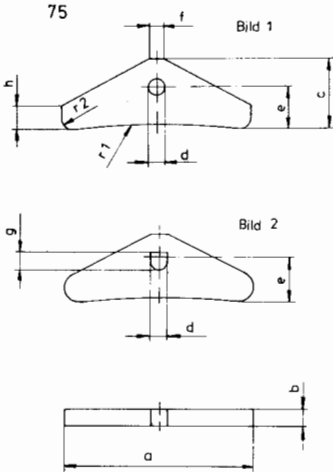
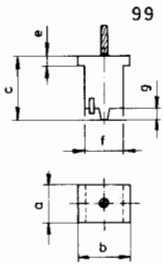
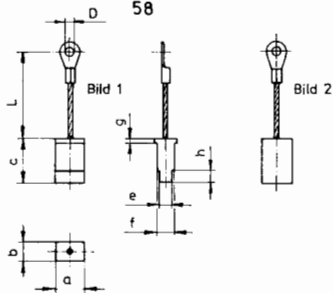
Reference	Abmessungen - dimensions							Bemerkungen remarks remarques					
	a	b	c	d	e	f	r						
05. 96. 01	25	20	32	M5	9	8	100						
Reference	Abmessungen - dimensions											Bemerkungen remarks remarques	
	a	b	c	d	e	f	g	h	r	Bild			
05. 75. 01	59	4	21	6,4	15	6	5	-	287,5	2			
05. 75. 02	50	4	18	4	11	4	-	6	284	1			
Reference	Abmessungen - dimensions						Bemerkungen remarks remarques						
	a	b	c	e	f	g							
07. 99. 01	10	14	17	2,5	10	3							
Reference	Abmessungen - dimensions										Bemerkungen remarks remarques		
	a	b	c	e	f	g	h	L	D	Bild			
07. 58. 01	37,5	29,5	43	-	-	-	-	100	6,5	2	ähnlich		
07. 58. 02	16	11,5	24	7	10	2,5	6	45	3,5	1			
07. 58. 03	16	11,5	24	-	10	2,5	-	45	3,5	1			

Reference	Abmessungen - dimensions							Bemerkungen remarks remarques
	a	b	c	d	e	f	Bild	
05. 18. 01	d=5,5	32	44	43	-	-	1	<p>Bild 1</p>
05. 18. 02	d=4	36	46	21	5,5	18	2	

Reference	Abmessungen - dimensions							Bemerkungen remarks remarques
	a	b	c	d	e	f	g	
05. 19. 01	10	30	40	6,4	54	18	4	<p>19</p>

Reference	Abmessungen - dimensions								Bemerkungen remarks remarques
	a	b	c	d	e	f	g	r	
05. 89. 01	40	40	44	33	6	d=15	26	150	<p>89</p>

Reference	Abmessungen - dimensions					Bemerkungen remarks remarques
	a	c	d	e	f	
05. 90. 01	35	25	10	3	3	<p>90</p>

Reference	Abmessungen - dimensions					Bemerkungen remarks remarques				
	a	c	d	e	L					
05. 66. 01	16	25,4	9,5	1,5	180	Ende verzinkt				
Reference	Abmessungen - dimensions								Bemerkungen remarks remarques	
	a	b	c	e	f	d	h	L		
05. 93. 01	30	27	28	19	15	9	10	40	in MS Buchse eingepreßt	
05. 93. 02	29,5	27,2	32,5	d = 29,5	12	8	8	57,5		
05. 93. 03	30	27	28	19	15	8	8	50		
05. 93. 04	30	27	28	19	15	9	10	50		
Reference	Abmessungen - dimensions								Bemerkungen remarks remarques	
	a	b	c	e	f	d	L	D		
07. 81. 01	27,8	23,8	40	5	12	22,5	210	6,3	Litze 16°	

Reference	Abmessungen - dimensions									Bemerkungen remarks remarques	
	a	b	c	e	f	g	L	D	Bild		
05. 65. 01	10	6,4	16,5	5	2,5	4	50	4,2	1		
05. 65. 02	10	6,4	16,5	5	2,5	4	50	4,2	2		

Reference	Abmessungen - dimensions									Bemerkungen remarks remarques	
	a	c	d	e	f	g	h	r	Bild		
05. 79. 01	80	58	M10	30	12	-	-	50	1	Kugelradius Kühlschlitz 3 x 15 Bohrung d = 30x15 Bohrung d = 25x34, Schlitz 9 x 5	
05. 79. 02	80	58	M10	45	15	-	-	87	1		
05. 79. 03	60	22	8,5	40	6,5	14,5	32	130	1		
05. 79. 04	60	30	8,5	40	8	15	32	-	2		
05. 79. 05	60	22	8,5	40	6	-	30	-	1		
05. 79. 06	45	34	-	-	-	9	25	220	3		
05. 79. 07	49,5	30	6	-	24	-	-	111	4		
05. 79. 08	60	22	6,4	44	-	8	30	-	5		
05. 79. 09	60	22	6,4	44	-	8	30	80	5		
05. 79. 10	60	22	6,4	44	-	8	30	90	5		
05. 79. 11	60	22	6,4	44	-	8	30	135	5		
05. 79. 12	60	22	8,5	40	6	8,5	30	-	1		

Reference	Abmessungen - dimensions								Bemerkungen remarks remarques	
	a	c	e	f	g	h	i	Bild		
05. 95. 01	45	38	32,5	32	8,5	-	-	1	1/2 verkupfert	
05. 95. 02	45	38	32,5	-	-	-	-	1	1/2 verkupfert	
05. 95. 03	40	38	35	-	-	31	6	2	Radius	
05. 95. 04	45	38	31,5	-	-	-	-	~1		

Reference	Abmessungen - dimensions				Bemerkungen remarks remarques	
	a	b	c	r		
05. 08. 01	75	42	46	150	Kugelradius 1/2 verk.	
05. 08. 02	66	33	29	161	Kühlschl. 60° versetzt, 6 Gew. M4auf Teilkr. d = 50	
05. 08. 03	29	8	16	-		
05. 08. 04	75	42	44,75	150		



Reference	Abmessungen - dimensions								Bemerkungen remarks remarques
	a	b	c	e	f	g	d	Bild	
05.01.01	22	12	15	11	15	-	-	1	
05.01.02	22	12	15,5	11	15	-	-	1	
05.01.03	22	12	12	11	13,5	-	-	1	
05.01.04	35	15	19	17,5	17,5	-	-	1	
05.01.05	40	22	17,2	20	15,2	-	-	1	
05.01.07	35	15	15	10	-	7,5	-	2	
05.01.08	33	10	10	8	-	5	-	2	
05.01.09	40	22	18	20	16	6	-	1	

Reference	Abmessungen - dimensions								Bemerkungen remarks remarques
	a	b	c	e	f	g	h	d	
05.92.01	25	14	19	35	10	45	10	5	
05.92.02	20	20	23,5	34	10	46,5	11	5	
05.92.03	60	18	33	78	18	94	12,5	6,4	

Reference	Abmessungen - dimensions								Bemerkungen remarks remarques
	a	b	c	d	e	f	r	Bild	
05.05.01	24	15	10	M5	8	3	7	1	<p>Größe der Befestigungsschrauben z.B. M5 x 15 bei Bestellung angeben.</p>
05.05.02	20	14	13	M6	6	3	10	3	
05.05.03	31	25	13,5	1/4"	11	3	15,5	3	
05.05.06	31	15	13,5	1/4"	11	3	15,5	3	
05.05.07	31	15	13,5	1/4"	8	3	15,5	3	
05.05.08	31	20	13,5	1/4"	11	3	15,5	3	
05.05.09	31	12	13,5	1/4"	11	3	15,5	3	
05.05.10	15,5	12	6	3/16"	5	3	8	3	
05.05.11	20	10	11	3/16"	8	3	10	3	
05.05.12	28	11	15	M5	10	-	9	1	
05.05.13	28	20	15	M6	10	-	9	1	
05.05.14	28	26	15	M6	10	-	9	1	
05.05.15	24	20	12	M5	8	-	6	1	
05.05.16	24	12	12	M5	8	-	6	1	
05.05.17	28	25	15	M6	10	-	9	3	
05.05.18	28	10	13	M5	10	3,5	9,5	3	
05.05.19	24	15	10	M5	8	3,5	11,5	1	
05.05.20	24	20	10	M5	8	3	10	3	

Kohlekontakte für Schalter, Schütze und Aufzüge

Reference	Abmessungen - dimensions								Bemerkungen remarks remarques
	a	b	c	d	e	f	g	r	
07. 141. 01	14,3	12,5	12,5	1	3,5	2,5	3	8	

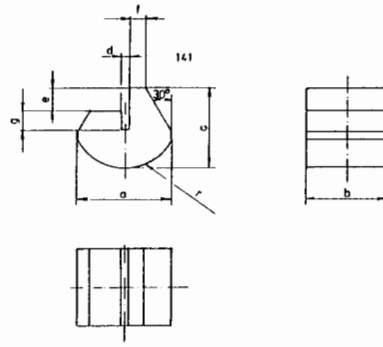

Reference	Abmessungen - dimensions								Bemerkungen remarks remarques
	a	b	c	d	e	f	r	Bild	
05. 06. 01	28	25	13	M6	10	3	5	1	Größe der Befestigungsschrauben z.B. M5 x 15 bei Bestellung angeben.
05. 06. 02	28	15	13	M6	10	3	5	1	
05. 06. 03	26	20	14	M5	10,5	3	5	1	
05. 06. 04	24	15	13	M5	10	3,5	5	1	
05. 06. 05	24	12	12,5	M5	12	4	-	2	
05. 06. 06	24	20	12	M5	8	3	5	1	
05. 06. 07	26	14	15	M5	10,5	3	5	1	
05. 06. 08	20	12	10	M4	5	3	-	2	
05. 06. 09	24	15	10	M5	8	3	8	1	
05. 06. 11	28	12	13	M6	10	3	5	1	
05. 06. 12	24	12	15,5	M5	12,5	3	6	1	
05. 06. 13	24	30	13	M6	10	3	8	1	
05. 06. 14	24	25	13	M5	10	3,5	20	1	
05. 06. 15	28	15	13,5	1/4 "	11,5	3	11	1	
05. 06. 16	28	20	13,5	1/4 "	11,5	3	11	1	
05. 06. 17	28	25	13	M6	10	3,5	9	1	
05. 06. 18	24	15	13	M4	10	3,5	9	1	
05. 06. 19	28	19	17	M6	10	3	6	1	
05. 06. 20	24	20	13	M6	10	3	8	1	
05. 06. 21	24	25	13	M6	10	3	8	1	



Bild 1



Bild 2

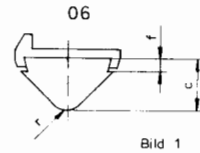

Reference	Abmessungen - dimensions							Bemerkungen remarks remarques
	a	b	c	d	e	f	Bild	
05. 44. 01	20	20	10,5	M5	8	8	1	Kontakt Radius
05. 44. 02	23	20	12	M5	8,5	r6	1	
05. 44. 03	20	20	11	M5	8,5	8	1	
05. 44. 04	21	20	15	M5	8,5	7	2	
05. 44. 05	20	20	12	M5	8,5	7,5	1	

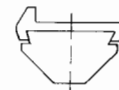
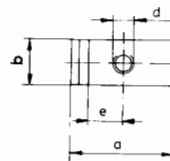
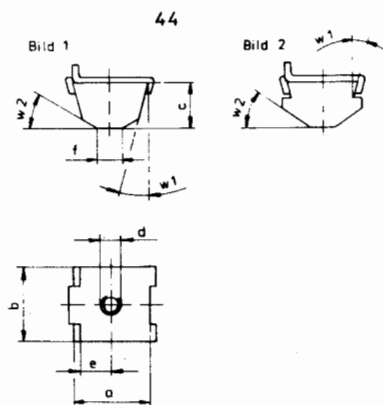

Reference	Abmessungen - dimensions								Bemerkungen remarks remarques	82
	a	b	c	d	e	f	g	w°		
05. 82. 01	34	15	17	M6	16	3	7	6		
05. 82. 02	34	8	22	M5	16	3	7	6		
05. 82. 03	42	16	18	M6	16	5	-	6		

Reference	Abmessungen - dimensions							Bemerkungen remarks remarques	07
	a	b	c	d	e	f	r		
05. 07. 01	22	12	13	M5	6	4,5	8		

Reference	Abmessungen - dimensions								Bemerkungen remarks remarques	Bild 2	03
	a	b	c	d	e	f	r	Bild			
05. 03. 01	20	20	14,5	M6	8	4,5	10	1			
05. 03. 02	20	15	14,5	M6	8	5	10	1			
05. 03. 03	25	15	12	M5	10	6,5	22	1			
05. 03. 04	25	18	15	M6	10	5	14	1			
05. 03. 05	25	12	13	M6	10	5	14	1			
05. 03. 06	25	20	16	M6	8,5	5	5	2			

  

Reference	Abmessungen - dimensions						Bemerkungen remarks remarques	77
	a	b	c	e	f	r		
05. 77. 01	13,5	12	5	2,5	6	20		

  

Reference	Abmessungen - dimensions								Bemerkungen remarks remarques	Bild 2	04
	a	b	c	d	e	f	r	Bild			
05. 04. 01	30	12	13,5	M4	19	5	11	1			
05. 04. 02	21	20	13	M6	-	3,5	-	2	1 Bohrung mittig		
05. 04. 03	35	25	15,5	M4	18	5	12	2			
05. 04. 04	20	16	10	M5	-	4	2	2	1 Bohrung mittig		
05. 04. 05	35	30	15,5	M5	18	5	12	2			
05. 04. 06	16	14	10	M4	-	4	2	2	1 Bohrung mittig		
05. 04. 07	25	15	16	M5	-	8	10	1	1 Bohrung mittig		
05. 04. 08	15,8	14	10	M4	-	3,5	2	2	1 Bohrung mittig		

Reference	Abmessungen - dimensions							Bemerkungen remarks remarques
	a	b	c	d	e	f	r	
05. 10. 01	20	15	15	M6	8	3,5	5	Befestigungs- schrauben z.B. M5 x 15 Größe und Ausführ- ung bei Bestellung angeben.
05. 10. 02	25	12	15	M5	9	4,5	9	
05. 10. 03	25	20	20	M6	9	4,5	6	
05. 10. 04	26	20	20	M6	11	4	10	
05. 10. 05	27	25	15	M6	9	6	9	
05. 10. 06	11	8,5	7	M3	4,5	-	11	
05. 10. 07	27	20	15	M6	15	6	6	
05. 10. 08	26	12	12	M5	8	4	6	
05. 10. 09	18	12	19	M4	7	4	5	
05. 10. 10	20	20	11,2	M5	6	3	5	
05. 10. 11	26	15	12	M5	8	4	6	
05. 10. 12	26	20	12	M5	8	4,5	6	
05. 10. 13	35	15	15	M6	13	5	25	
05. 10. 14	27	24	15	M6	11	6	6	
05. 10. 15	17,7	14	9	M4	9	4	5	
05. 10. 16	22	10	12	M5	8	4	8	
05. 10. 17	30	16	12	M5	11	4,5	10	
05. 10. 18	33	20	20	M6	12	5	10	
05. 10. 19	26	25	12	M5	9	5,5	7,5	

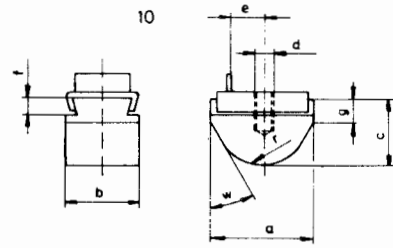

Reference	Abmessungen - dimensions							Bemerkungen remarks remarques
	a	b	c	d	e	r	Bild	
05. 28. 01	19	12,7	14,7	M6	3,5	10	1	MS Schraube M6 x 15
05. 28. 02	22,22	14,28	9,92	M5	4	11,5	1	MS Schraube M5 x 15
05. 28. 03	25,4	12,7	12,5	M5	4	13	1	MS Schraube M5 x 15
05. 28. 04	25,4	19,05	11,5	M5	4	13	1	MS Schraube M5 x 15
05. 28. 05	31,75	15,87	14,28	M6	4	16	1	MS Schraube M6 x 15
05. 28. 06	22,22	19,05	9,52	M5	4	11	1	MS Schraube M5 x 10
05. 28. 07	25,4	25,4	12,7	M5	4	12,5	1	MS Schraube M5 x 15
05. 28. 08	31,75	15,87	16,5	M5	4,6	16	1	MS Schraube M5 x 17
05. 28. 09	15	14	9	M5	4	3,5	2	MS Schraube M5 x 15
05. 28. 10	19,05	12,7	8,73	M5	3,5	10	1	
05. 28. 11	22	12,7	13	M5	4	11	1	
05. 28. 12	31,75	14	13	M5	4	16,5	1	
05. 28. 13	32	19	16	M5	4	16	1	
05. 28. 14	12,7	9,5	12,5	M5	4	6,5	1	
05. 28. 15	32	12,7	15	M5	4	16	1	
05. 28. 16	15,87	12,7	12,7	5/16"	5	-	2	

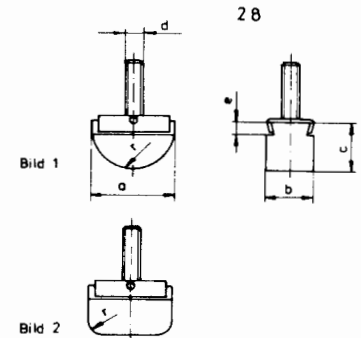

Reference	Abmessungen - dimensions								Bemerkungen remarks remarques
	a	b	c	d	e	f	g	r	
05. 27. 01	12,7	9,5	12	M4	4	10	9	6,5	

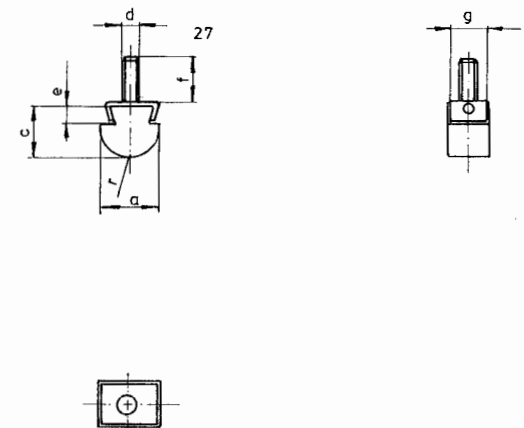

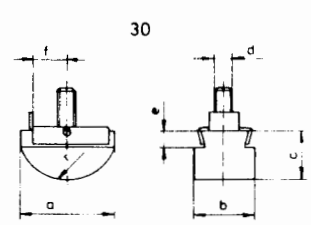
Reference	Abmessungen - dimensions								Bemerkungen remarks remarques
	a	b	c	d	e	f	g	r	
05. 30. 01	23,5	15	13	M5	4,5	9	11,5		
05. 30. 02	25,4	12,5	12	M5	4,5	9	12,5		
05. 30. 03	25,4	16	12,7	M5	4	9	13,5		
05. 30. 04	19,1	12,7	11	M5	4,5	6,5	9		
05. 30. 05	17,5	16	5,5	M5	9	2,5	20		
05. 30. 06	25,4	19,5	12,7	M5	4	9	13,5		

Reference	Abmessungen - dimensions								Bemerkungen remarks remarques
	a	b	c	d	e	f	g	r	
05. 31. 01	24	25	11	M5	5	8	12	6	

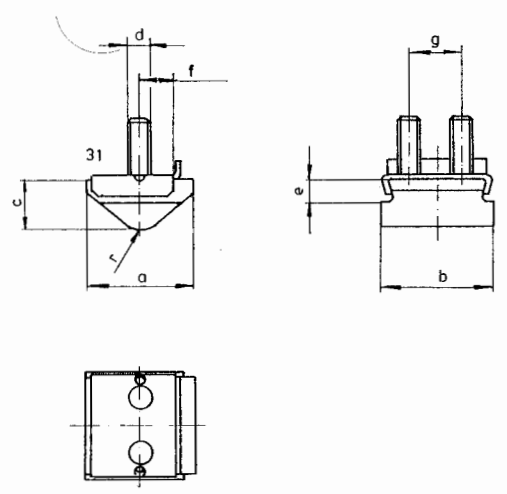

Reference	Abmessungen - dimensions						Bemerkungen remarks remarques			
	a	b	c	d	e	r				
05. 29. 01	25,5	25,5	13	M5	4,5	12,5				
05. 70. 01	25,5	25,5	11	M5	5	8,5	12			
05. 32. 01	22,8	12	17	M6	6	6,5	4	13	Blecheinfassung	
05. 91. 01	17	12	11	M4	5	4	4	2,5	Gew.Buchse eingelötet	

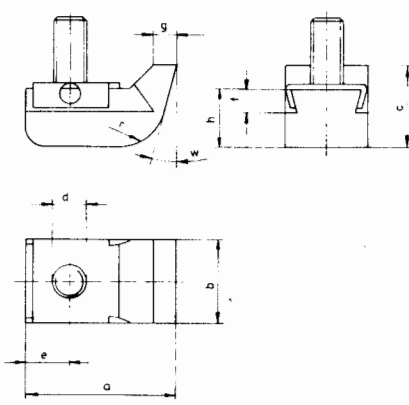
Reference	Abmessungen - dimensions									Bemerkungen remarks remarques	72 
	a	b	c	d	e	f	g	r	h		
05. 72. 01	23	13	13	M5	7	3,5	3,5	7	9		

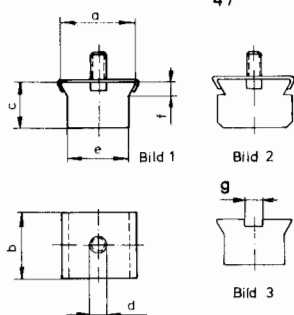

Reference	Abmessungen - dimensions								Bemerkungen remarks remarques	47 
	a	b	c	d	e	f	g	Bild		
07. 47. 01	40	35	23,5	M8	33	8	-	1		
07. 47. 02	41	35	23,5	M8	41	7	-	2		
07. 47. 05	39	35	23,5	-	33	8	10	3		

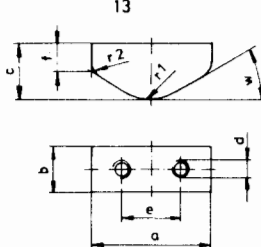

Reference	Abmessungen - dimensions							Bemerkungen remarks remarques	13 
	a	b	c	d	e	f	r1		
05. 13. 01	32	12	15,5	M5	16	8	13		
05. 13. 02	24	12	14	M4	11	10	18		
05. 13. 03	50	8	25	M3	25	-	25	MS Gew. Einlage	

Reference	Abmessungen - dimensions						Bemerkungen remarks remarques	26 
	a	a1	b	c	r	r1		
05. 26. 01	9,5	7,2	8,4	5,2	5	3,75		

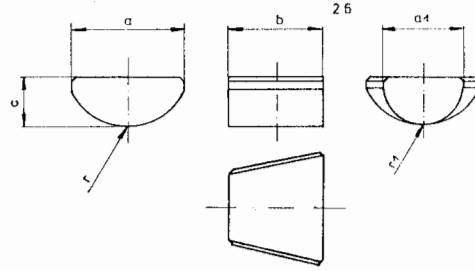

Reference	Abmessungen - dimensions							Bemerkungen remarks remarques	73 
	a	b	c	d	e	f	g		
05. 73. 01	32	10	17	3,2	13	3,5	7,5	Winkel° bei Bestellung angeben Halterung für den Kontakt extra bestellen	

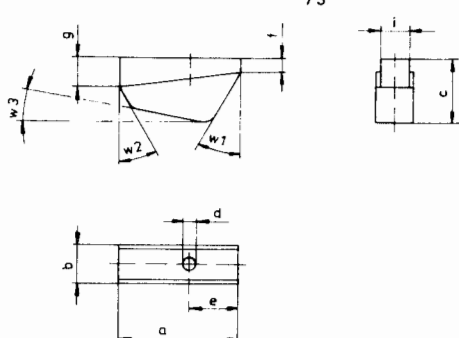
Reference	Abmessungen - dimensions											Bemerkungen remarks remarques		
	a	b	c	d	e	f	g	h	i	k	r			w
05. 83. 01	40,5	8	17	3,2	17	6	5,5	6	5	2	10	10		
Reference	Abmessungen - dimensions							Bemerkungen remarks remarques						
	a	b	c	d	e	f	g							
05. 43. 01	44	24	14	6	10	20	11							
05. 43. 02	47	24	21	5,7	9	8,5	15							
Reference	Abmessungen - dimensions									Bemerkungen remarks remarques				
	a	b	c	d	e	f	g	h	r					
05. 78. 01	38	25	16	4,5	13	7	14	12	100	verk.				
Reference	Abmessungen - dimensions											Bemerkungen remarks remarques		
	a	b	c	d	e	f	g	h	i	r	w			
05. 80. 01	52	14	25	4,5	15	8,5	30	12	5	10	30			
Reference	Abmessungen - dimensions		Bemerkungen remarks remarques											
	a	c												
05. 63. 01	12	4												

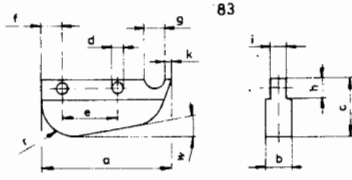
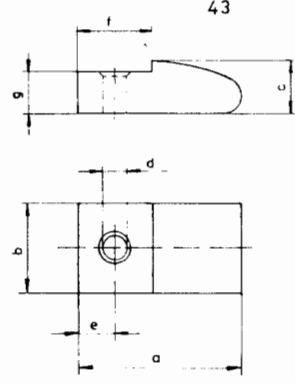
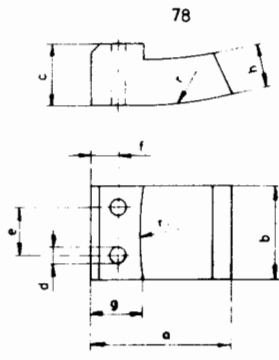
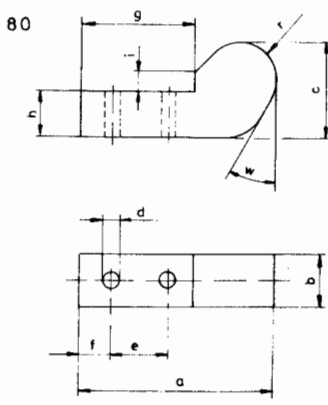
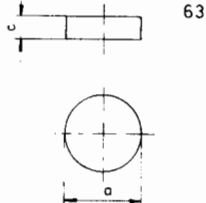

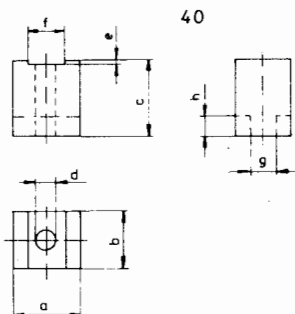
Reference	Abmessungen - dimensions								Bemerkungen remarks remarques
	a	b	c	d	e	f	g	h	
05. 40. 01	18	15	20	5,3	1	10	-	-	Stirnfl. verk.  
05. 40. 02	20	15	20	5,6	1,5	10,5	-	-	
05. 40. 03	18	10	15	4,7	1,5	10,5	-	-	
05. 40. 04	25	20	25	6,3	2	15	-	-	
05. 40. 05	18	10	15	4,5	1,7	10,5	15	6	
05. 40. 06	25	18	20	5,2	1	10	-	-	
05. 40. 07	27	20	25	6,3	2	15,2	-	-	

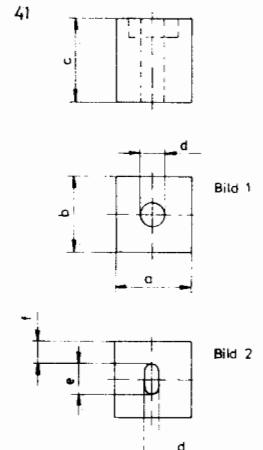
Reference	Abmessungen - dimensions							Bemerkungen remarks remarques
	a	b	c	d	e	f	Bild	
05. 41. 01	19	19	19	6,5	-	-	1	Sackloch d = 6,5x7 Gew. M4 Kont. fl. verk.  
05. 41. 02	10	10	20	M4	-	-	1	
05. 41. 03	42	42	20	6	-	-	1	
05. 41. 04	32	20	32	5	15	8,5	2	
05. 41. 05	30	15	30	4	7	5	2	
05. 41. 06	20	10	19	4,5	-	-	1	
05. 41. 07	20	10	13	4,5	-	-	1	
05. 41. 08	30	15	30	4	10	10	2	

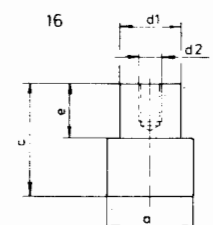
Reference	Abmessungen - dimensions					Bemerkungen remarks remarques
	a	c	e	d1	d2	
05. 16. 01	16	14	8	12	-	verk.  
05. 16. 02	45	60	29	32	1/2"	

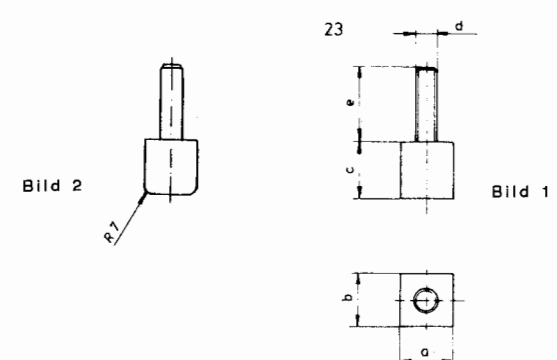
Reference	Abmessungen - dimensions						Bemerkungen remarks remarques
	a	b	c	e	d	Bild	
05. 23. 01	14	14	15	20	M6	1	verk.  
05. 23. 02	30	30	24	10	M12	2	

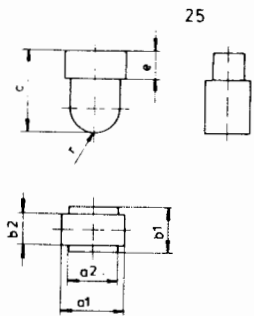
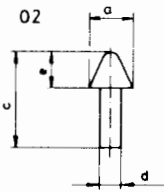
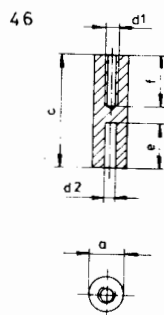
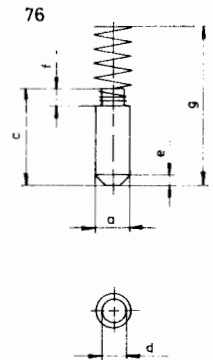
Reference	Abmessungen - dimensions							Bemerkungen remarks remarques
	a1	a2	b1	b2	c	e	r	
05. 25. 01	16,5	13	8,5	12	21,5	7,5	6,5	
Reference	Abmessungen - dimensions				Bemerkungen remarks remarques			
	a	c	d	e				
05. 02. 01	11,5	25,5	5,95	9,5				
05. 02. 02	8,5	23	5,95	7				
								
Reference	Abmessungen - dimensions						Bemerkungen remarks remarques	
	a	c	d1	d2	e	f		
05. 46. 01	9	30	M4	3,5	12	14		
05. 46. 02	9	30	M4	-	-	14		
Reference	Abmessungen - dimensions						Bemerkungen remarks remarques	
	a	c	d	e	f	g		
05. 76. 01	d=3	8,5	1,7	1	1,5	14	o.A., o.F.	
05. 76. 02	2,9	11,5	-	0,47	-	-		
05. 76. 03	d=3	8,5	-	1	1,5	14		
								

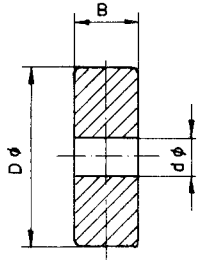
Reference	Abmessungen - dimensions				Bemerkungen remarks remarques
	D	d	B		
05. 201. 01	15	4	8		
05. 201. 02	15	4	10		
05. 201. 03	20	6	10		
05. 201. 04	25	6	10		
05. 201. 05	25	6	15		
05. 201. 06	30	6	15		
05. 201. 07	35	6	15		

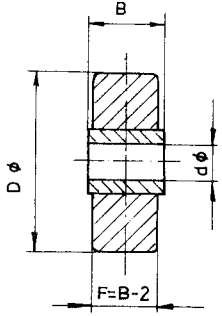
Reference	Abmessungen - dimensions				Bemerkungen remarks remarques
	D	d	B		
05. 202. 01	15	4	8		
05. 202. 02	15	4	10	mit Sinterlager	
05. 202. 03	20	6	10	mit Sinterlager	
05. 202. 04	25	6	10	mit Sinterlager	
05. 202. 05	25	6	15	mit Sinterlager	
05. 202. 06	30	6	15	mit Sinterlager	
05. 202. 07	35	6	15	mit Sinterlager	

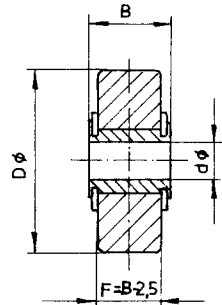
Reference	Abmessungen - dimensions				Bemerkungen remarks remarques
	D	d	B		
05. 203. 01	15	4	8		
05. 203. 02	15	4	10	mit Cu-Laufbuchse und MS-Scheiben	
05. 203. 03	20	6	10	mit Cu-Laufbuchse und MS-Scheiben	
05. 203. 04	25	6	10	mit Cu-Laufbuchse und MS-Scheiben	
05. 203. 05	25	6	15	mit Cu-Laufbuchse und MS-Scheiben	
05. 203. 06	30	6	15	mit Cu-Laufbuchse und MS-Scheiben	
05. 203. 07	35	6	15	mit Cu-Laufbuchse und MS-Scheiben	

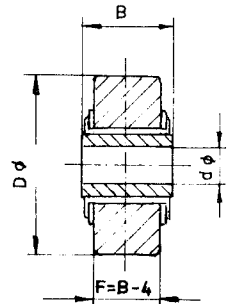
Reference	Abmessungen - dimensions				Bemerkungen remarks remarques
	D	d	B		
05. 204. 01	15	4	8		
05. 204. 02	15	4	10	mit Cu-Rohrmet und Sinterlager	
05. 204. 03	20	6	10	mit Cu-Rohrmet und Sinterlager	
05. 204. 04	25	6	10	mit Cu-Rohrmet und Sinterlager	
05. 204. 05	25	6	15	mit Cu-Rohrmet und Sinterlager	
05. 204. 06	30	6	15	mit Cu-Rohrmet und Sinterlager	
05. 204. 07	35	6	15	mit Cu-Rohrmet und Sinterlager	

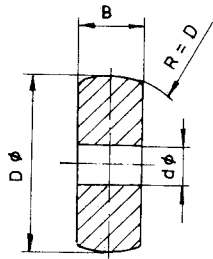
Reference	Abmessungen - dimensions				Bemerkungen remarks remarques
	D	d	B	R	
05. 205. 01	15	4	8		
05. 205. 02	15	4	10		
05. 205. 03	20	6	10		
05. 205. 04	25	6	10		
05. 205. 05	25	6	15		
05. 205. 06	30	6	15		
05. 205. 07	35	6	15		
05. 205. 08	20	5	8		
05. 205. 09	20	7,7/5,7	8	8	

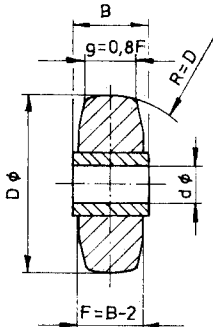
Reference	Abmessungen - dimensions				Bemerkungen remarks remarques
	D	d	B	R	
05. 206. 01	15	4	8		
05. 206. 02	15	4	10		
05. 206. 03	20	6	10		
05. 206. 04	25	6	10		
05. 206. 05	25	6	15		
05. 206. 06	30	6	15		
05. 206. 07	35	6	15		
05. 206. 08	37	6	15		

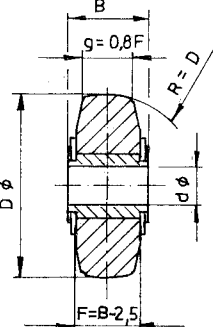
Reference	Abmessungen - dimensions				Bemerkungen remarks remarques
	D	d	B	R	
05. 207. 01	15	4	8		
05. 207. 02	15	4	10		
05. 207. 03	20	6	10		
05. 207. 04	25	6	10		
05. 207. 05	25	6	15		
05. 207. 06	30	6	15		
05. 207. 07	35	6	15		

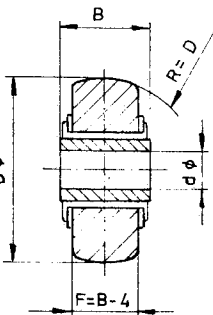
Reference	Abmessungen - dimensions				Bemerkungen remarks remarques
	D	d	B	R	
05. 208. 01	15	4	8		
05. 208. 02	15	4	10		
05. 208. 03	20	6	10		
05. 208. 04	25	6	10		
05. 208. 05	25	6	15		
05. 208. 06	30	6	15		
05. 208. 07	35	6	15		
05. 208. 08	25	6	15		

Reference	Abmessungen - dimensions						Bemerkungen remarks remarques
	D	d1	d2	B	f	r	
05. 209. 01	18	5	10	10	8	24	mit Bund            + 2 Bohrungen
05. 209. 02	25	6	12	15	12	26	
05. 209. 03	30	6	12	11	10	20	
05. 209. 04	12	4	6	4,5	4	12	
05. 209. 05	20	4	8	8	6	20	
05. 209. 06	12	5	6	4,5	4	12	
05. 209. 07	15	5,05	7	10	8	15	
05. 209. 08	32	6,1	12	12,5	10	-	
05. 209. 09	32	6	12	12,5	10	40	
05. 209. 10	40	6	12	15	12	-	
05. 209. 11	28	6	12	11	10	-	
05. 209. 12	60	30	50	30	18	35	

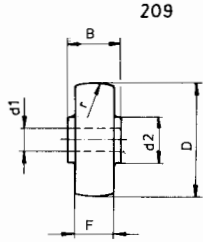

209

Reference	Abmessungen - dimensions				Bemerkungen remarks remarques
	D	d1	B	r	
05. 210. 01	11	3,2	4	20	
05. 210. 02	11	3,2	4	20	

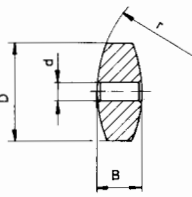

210

Reference	Abmessungen - dimensions							Bemerkungen remarks remarques
	D	d1	d2	d3	B	F	r	
05. 211. 01	38	6	10	30	15	11	50	seitl. Scheiben Sinterlager

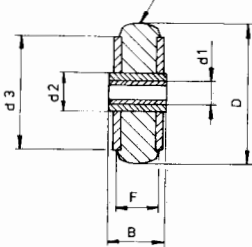

211

Reference	Abmessungen - dimensions				Bemerkungen remarks remarques
	D	d	B	F	
05. 212. 01	30	6	24	10,5	seitl. Scheiben mit fester Achse

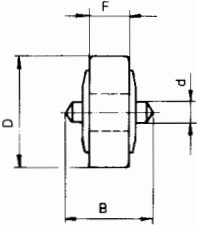

212

Reference	Abmessungen - dimensions						Bemerkungen remarks remarques
	a	b	c	d	e	f	
05. 213. 01	40	37	11	8	13	4	

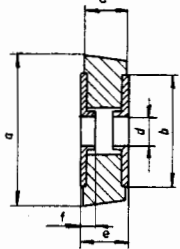

213

Reference	Seite
07. 01. xx	7
07. 02. xx	1
07. 03. xx	8
07. 04. xx	9/10
07. 05. xx	1
07. 06. xx	2
07. 07. xx	10
07. 08. xx	10
07. 09. xx	11
07. 10. xx	11
07. 11. xx	11
07. 12. xx	8
07. 13. xx	13
07. 14. xx	14
07. 15. xx	4
07. 16. xx	14
07. 17. xx	11
07. 18. xx	3
07. 19. xx	3
07. 20. xx	17
07. 21. xx	18
07. 22. xx	18
07. 23. xx	18
07. 26. xx	12
07. 27. xx	4
07. 28. xx	15
07. 29. xx	2
07. 31. xx	19
07. 32. xx	2
07. 34. xx	2
07. 37. xx	20
07. 38. xx	24
07. 39. xx	24
07. 40. xx	35
07. 41. xx	35
07. 42. xx	35
07. 43. xx	34
07. 44. xx	28

Reference	Seite
07. 45. xx	3
07. 46. xx	34
07. 49. xx	30
07. 50. xx	5
07. 53. xx	22
07. 54. xx	12
07. 55. xx	12
07. 56. xx	16
07. 58. xx	36
07. 59. xx	33
07. 60. xx	5
07. 61. xx	5
07. 63. xx	5
07. 64. xx	17
07. 65. xx	5
07. 67. xx	6
07. 68. xx	32
07. 70. xx	3
07. 71. xx	33
07. 72. xx	19
07. 73. xx	24
07. 74. xx	17
07. 75. xx	6
07. 76. xx	25
07. 77. xx	25
07. 78. xx	32
07. 79. xx	27
07. 80. xx	27
07. 81. xx	38
07. 82. xx	7
07. 83. xx	34
07. 84. xx	33
07. 85. xx	21
07. 86. xx	25
07. 87. xx	31
07. 88. xx	22
07. 89. xx	20
07. 90. xx	30

Reference	Seite
07. 93. xx	32
07. 94. xx	32
07. 95. xx	12
07. 96. xx	4
07. 97. xx	13
07. 99. xx	36
07. 100. xx	29
07. 101. xx	26
07. 102. xx	22
07. 103. xx	23
07. 104. xx	4
07. 105. xx	25
07. 106. xx	20
07. 107. xx	21
07. 108. xx	28
07. 109. xx	29
07. 110. xx	28
07. 111. xx	30
07. 112. xx	31
07. 113. xx	35
07. 114. xx	29
07. 115. xx	26
07. 116. xx	31
07. 117. xx	26
07. 118. xx	19
07. 120. xx	8
07. 121. xx	3
07. 122. xx	19
07. 123. xx	28
07. 124. xx	34
07. 125. xx	31
07. 126. xx	4
07. 127. xx	29
07. 128. xx	13
07. 129. xx	10
07. 130. xx	16
07. 131. xx	23
07. 134. xx	21

Reference	Seite
07. 136. xx	26
07. 137. xx	27
07. 138. xx	23
07. 139. xx	27
07. 140. xx	6
07. 141. xx	41
07. 142. xx	21
07. 143. xx	33
07. 144. xx	25
07. 145. xx	24
07. 146. xx	24
07. 147. xx	28
07. 149. xx	26
07. 150. xx	23
P 0	18
P 4	18
P 5	18
P 10	18

Reference	Seite
05. 01. xx	40
05. 02. xx	49
05. 03. xx	42
05. 04. xx	42
05. 05. xx	40
05. 06. xx	41
05. 07. xx	42
05. 08. xx	39
05. 10. xx	43
05. 13. xx	46
05. 16. xx	48
05. 18. xx	37
05. 19. xx	37
05. 23. xx	48
05. 25. xx	49
05. 26. xx	46
05. 27. xx	44

Reference	Seite
05. 28. xx	43
05. 29. xx	45
05. 30. xx	44
05. 31. xx	44
05. 32. xx	45
05. 40. xx	48
05. 41. xx	48
05. 43. xx	47
05. 44. xx	41
05. 46. xx	49
05. 63. xx	47
05. 65. xx	39
05. 66. xx	38
05. 70. xx	45
05. 72. xx	46
05. 73. xx	46
05. 75. xx	36

Reference	Seite
05. 76. xx	49
05. 77. xx	42
05. 78. xx	47
05. 79. xx	39
05. 80. xx	47
05. 82. xx	42
05. 83. xx	47
05. 89. xx	37
05. 90. xx	37
05. 91. xx	45
05. 92. xx	40
05. 93. xx	38
05. 95. xx	39
05. 96. xx	36

Reference	Seite
05. 201. xx	50
05. 202. xx	50
05. 203. xx	50
05. 204. xx	50
05. 205. xx	51
05. 206. xx	51
05. 207. xx	51
05. 208. xx	51
05. 209. xx	52
05. 210. xx	52
05. 211. xx	52
05. 212. xx	52
05. 213. xx	52